



www.linkhamson.com  
sales@linkhamson.com  
01494 439786



# ESD workspaces



Design your own workstation or trolley and view it in 3D

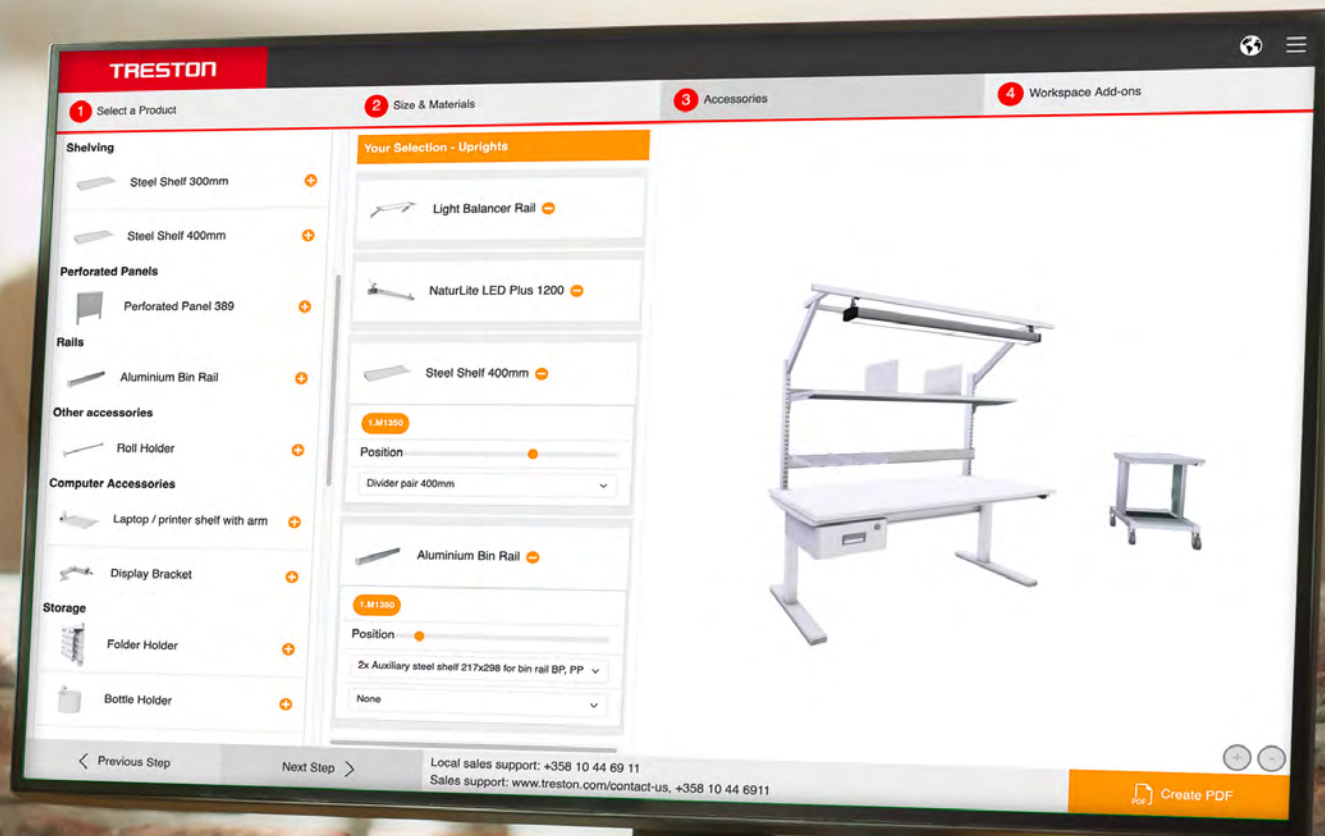

# ONLINE 3D

# CONFIGURATOR



[www.linkhamson.com](http://www.linkhamson.com)  
[sales@linkhamson.com](mailto:sales@linkhamson.com)  
01494 439786

**Improved user experience with our enhanced 3D Configurator!** The latest version boasts a suite of enhancements, ensuring a more intuitive, user-friendly, and visually appealing experience.

To get started, all you need is a mobile phone or a computer with internet browser; no downloading is required and using the software is free of charge.



# Workspaces for happier workfaces

## ESD protection in technical and industrial workplaces 4

## Workbenches

|   |    |
|---|----|
| Concept - the most versatile workbench        | 14 |
| WB - aesthetic and easily adaptable           | 18 |
| QuatreX - 4-legged electric workbench         | 20 |
| TED - electric desk for industrial use        | 22 |
| Quick Edge - extremely fast height adjustment | 24 |
| TP - ideal basic workbench                    | 25 |
| TPH - standard workbench with one shelf       | 27 |

## Workbench accessories

|  |    |
|--|----|
| ESD accessories for Concept, QuatreX, TED, Quick Edge and TP | 29 |
| ESD accessories for WB and QuatreX                           | 42 |
| ESD accessories for TPH                                      | 45 |
| Other ESD accessories  | 48 |
| Non ESD certified accessories                                | 49 |

## Lighting 53

## Chairs 57

## Trolleys

|                                   |    |
|-----------------------------------|----|
| Universal trolley WTR             | 60 |
| Treston Industrial Multi trolley  | 61 |
| Adjustable trolley TRTA           | 64 |
| Reel holder trolley RRT           | 65 |
| Mobile workstations               | 66 |
| Trolleys for additional workspace | 67 |
| Bin and cabinet trolley           | 68 |

## Drawer units

|                         |    |
|-------------------------|----|
| Light steel cabinet LMC | 70 |
| Drawer units 30 and 35  | 70 |
| Drawer unit 45          | 71 |

## Storage systems

|  |    |
|--|----|
| FiFo Flow Rack                               | 74 |
| Shelving system                              | 76 |
| Industrial cabinets                          | 76 |
| Shelving cabinets                            | 77 |
| Small-parts storage cabinets                 | 78 |
| Spacemisers for small-parts storage cabinets | 79 |
| Storage bin cabinets                         | 80 |
| Spacemisers for storage bin cabinets         | 80 |
| High density storage cabinets                | 81 |
| ESD bins                                     | 82 |

## Spare parts 83



# TRESTON

WORKSPACES FOR HAPPIER WORKFACES

# WORKSPACES FOR HAPPIER WORKFACES

There's no way around it. Sustainable long term business success in every industry is founded on empowered, motivated and healthy employees, and hyper adaptability to constant change.

The solution is simple.

A smart industrial workspace that adapts flexibly to the needs of the individual and the constant changes in the process. A next generation workstation and material flow solution that drives better business performance, environmental performance and personal performance by integrating and optimizing all work phases into a leaner, cleaner and greener process.

With decades of experience, in depth understanding of ergonomics in industrial environments, unmatched ESD competence and proven LEAN knowhow we at Treston are in a unique position to help our customers in keeping their business and people in good shape.

## Workspaces for happier workfaces.

This is our aspiration. This is our promise. This is what Treston is all about.

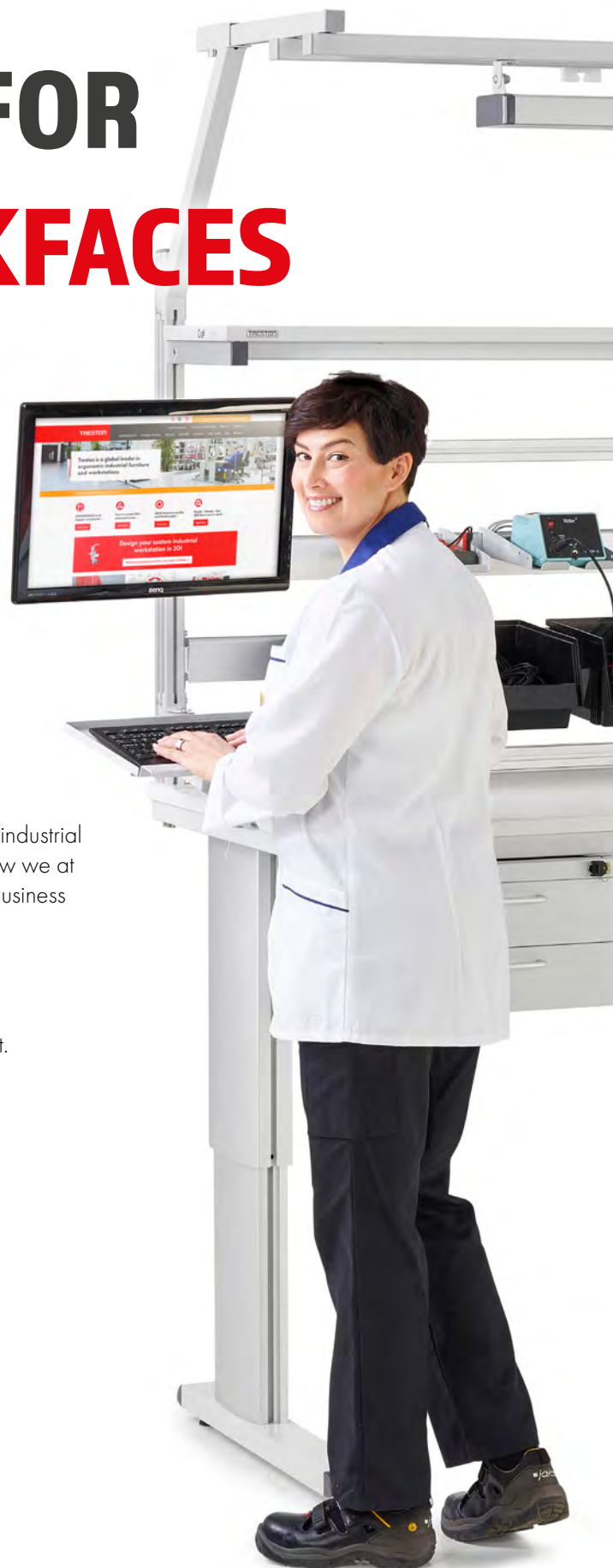

# ESD protection guarantees a safe working environment

Particularly in the electronics industry, work is often carried out in an ESD protected area (EPA) that is protected from static discharge. To create and maintain an EPA one needs to pay special attention to furniture and personnel, which need to be grounded. Protection can involve earthing equipment and painting the frame of the workstation with semi-conductive paint.

We have extensive experience in developing, manufacturing and supplying ESD furnishings. All our workstations and related products are available with an electrically semi-conductive coat of paint and we supply furnishings, seats and earthing components for ESD-protected workstations. We also build complete production systems equipped with ESD-protection. Our ESD-protected products meet the requirements specified in the IEC 61340-5-1 standard.

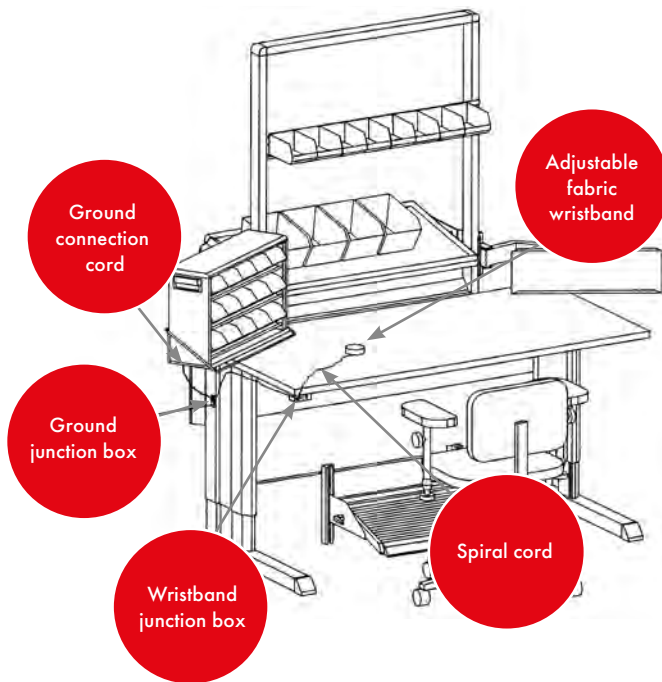

## Static electricity

The abbreviation ESD stands for Electrostatic Discharge, a process that occurs between two objects of differing electric potential. Normally, electric charges are discharged slowly from objects' surfaces. If the difference in electric potential becomes too high, the electrical current accelerates resulting in a sudden current surge.

An ESD protected area is called an EPA. In an EPA, ESD protection must be observed in all materials, employees' clothing and air humidity. Employees in an EPA must also be earthed with protective resistance (1 Mohm) to an ESD earth.

## Terms and explanations

|                            |   |
|----------------------------|---|
| <b>ESD</b>                 | <b>Electrostatic discharge.</b> Occurs when two electrically-charged objects come together and a charge is discharged. Could result in either immediate or latent damage to an electrical component |
| <b>ESDS</b>                | <b>Electrostatic discharge sensitive.</b> A component that needs ESD protection.  |
| <b>EPA</b>                 | <b>ESD-protected area.</b>  |
| <b>CONDUCTIVE MATERIAL</b> | <b>Conductor</b> = material that permits electricity flow. Metals are often conductive, e.g. copper and aluminium.  |
| <b>INSULATING MATERIAL</b> | <b>Insulator</b> = material that does not conduct electricity. The insulator can be electrostatically charged. Insulators can be plastic or wood, for example.                                      |
| <b>STANDARDS</b>           | <b>IEC 61340-5-1:</b> ESD standard widely used in Europe and ANSI S20.20 in the Americas. Both standards have a great number of similarities.   |

# ESD - Electrostatic discharge

In ordinary movement a person creates static electricity. In these circumstances hand contact with a conductive material will discharge static from the body very rapidly. This is ESD = Electrostatic discharge. Static electricity has become a major problem in the electronics industry. Usually this passes unnoticed because our bodies do not feel discharges below 3000 volts. We may see ESD above 5000 volts as a spark.

The most sensitive components may be damaged by a charge of just 30 volts, and many standard components

are sensitive to charges of 100...200 volts. The presence of inherent ESD is not easy to detect. Product-related defects can often be latent and become active over time. An unbroken ESD safety chain is essential to guarantee the quality of the final product. An ESD-protected production chain is called an EPA (= ESD Protected Area). Employees must be able to implement the right policies in an ESD-protected work environment.

## CHARGES GENERATED ON DAILY WORK ACTIVITIES

|  |                      |
|--|----------------------|
| <b>Walking across a carpet</b>             | 1 500 – 35 000 volts |
| <b>Walking over vinyl floor</b>            | 250 – 12 000 volts   |
| <b>Working at a bench</b>                  | 700 – 6 000 volts    |
| <b>Picking up a plastic bag from bench</b> | 1 200 – 20 000 volts |
| <b>Chair with polyurethane foam</b>        | 400 - 3 000 volts    |

The lower the relative humidity the higher the voltage. The lowest values in the table usually apply when the relative humidity is 65-90%. During a cold winter day, the relative humidity in indoor spaces can be as low as 10 %.

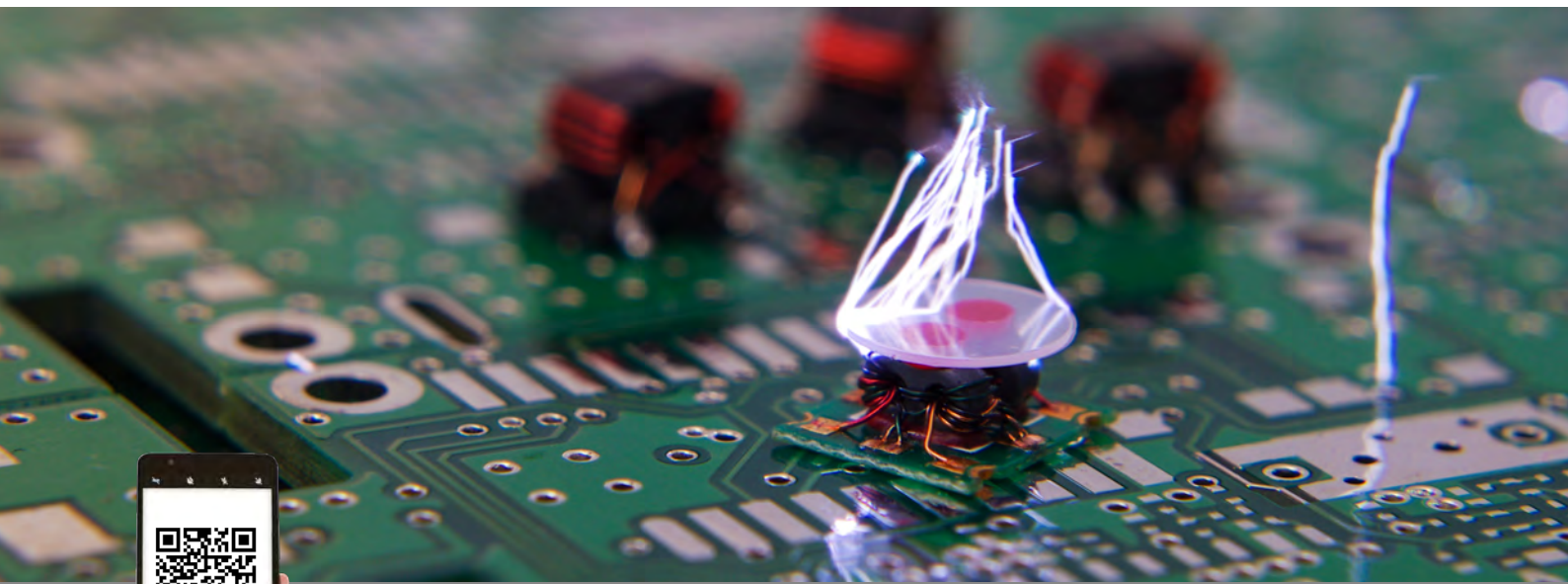

Watch this video: [ESD workstation management](#)



# Investing in an EPA is important

There are two types of ESD damage in industrial and technical environments. Firstly, a fatal defect that is usually easily detected during assembly or handling, or at least through careful testing. Such products are usually not delivered to customers. Secondly, another type of ESD damage is latent damage. This is difficult to detect with

bear eyes and the product may pass all tests and function normally for some time. However, latent damage affects the performance and durability of the product and often results in poor product quality.

## Static charge management of a working area:

- ESD-protected workstations. Attention paid to ESD safe storing, moving and packing.
- Personnel protected with shoes, wrist straps and other needed accessories
- Staff training, work instructions and quality control
- Cleanliness of ESD-protected equipment. Dust and dirt insulate.
- Commitment to continuous improvement in static electricity management

## Example of an ESD-protected area (EPA)

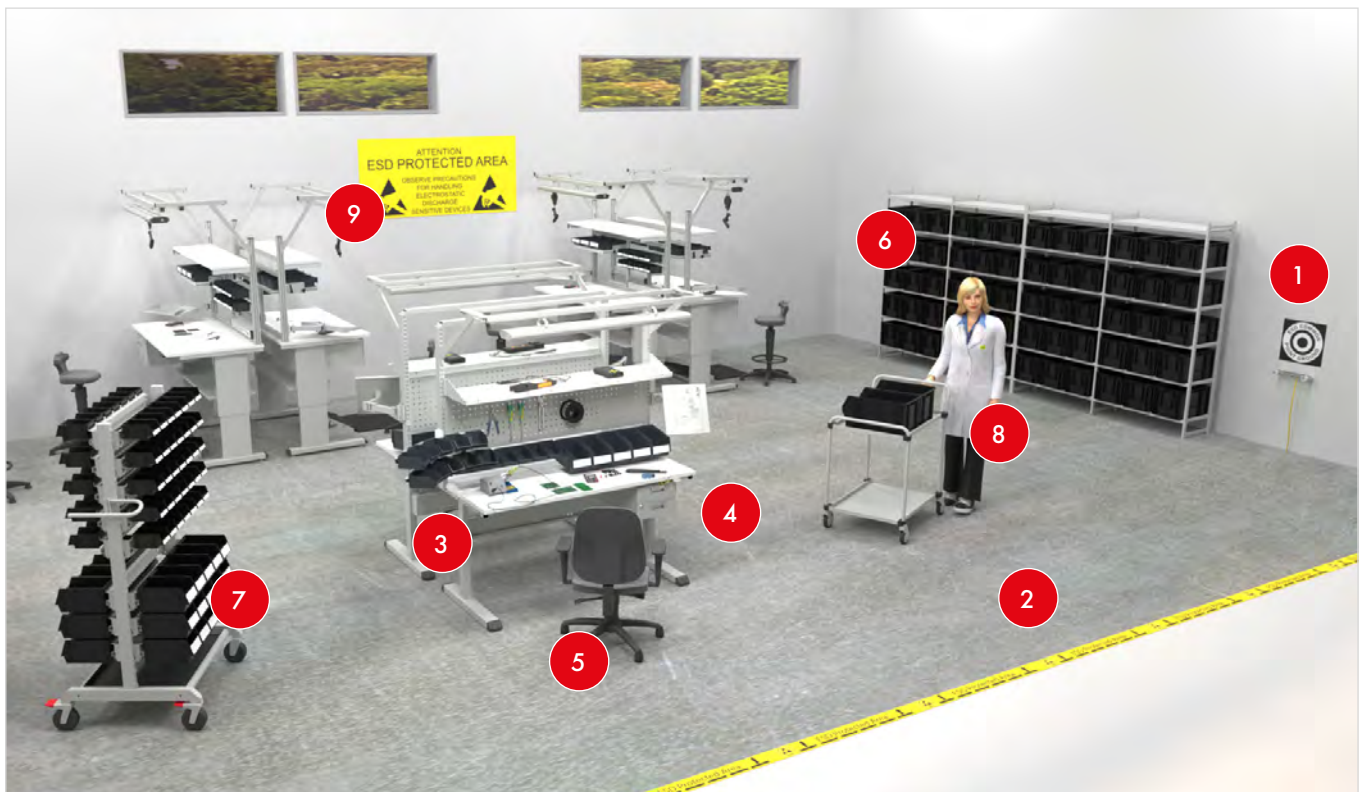

1. Common point ground
2. ESD floor
3. Semi-conductive table

4. Wrist strap + earth bounding point
5. Chair with ESD castors
6. Semi-conductive ESD shelf

7. Trolley with ESD castors
8. ESD garments (e.g. jacket and shoes)
9. EPA sign

# 6-Point checklist for creating and maintaining an EPA

|   |  |
|---|--|
| 1 | <b>CONTROL PLAN</b> Includes e.g. component/product sensitivity levels, ESD protection level, daily routines and maintenance procedures. |
| 2 | <b>FLOORING</b> Grounded ESD floor or mat enables convenient usage of trolleys and chairs in EPA.  |
| 3 | <b>FURNITURE</b> All furniture in EPA needs to be grounded.  |
| 4 | <b>PERSONNEL</b> Wrist strap is the most efficient way to ground people working on EPA.  |
| 5 | <b>STORING, MOVING AND PACKING</b> Store ESDS components in their original packages and minimise the transportation and movements.       |
| 6 | <b>CLEANING AND TESTING</b> Regular cleaning with ESD detergent in EPA maintains the ESD protection.                                     |

## ESD materials

|   |   |
|---|---|
| <p><b>Semi-conductive laminate level</b></p> <ul style="list-style-type: none"> <li>• Grounding resistance <math>10^6 - 10^8 \Omega</math></li> <li>• Surface resistance <math>10^6 - 10^9 \Omega</math></li> <li>• Withstands the heat of the soldering iron, most acids and bases</li> </ul>      | <p><b>Semi-conductive painted steel parts</b></p> <ul style="list-style-type: none"> <li>• Surface resistance <math>10^5 - 10^9 \Omega</math></li> </ul>  |
| <p><b>Semi-conductive Polypropylene = PP</b></p> <ul style="list-style-type: none"> <li>• Surface resistance <math>10^3 - 10^6 \Omega</math></li> <li>• Throughput <math>10^3 - 10^6 \Omega /</math></li> <li>• Temperature resistance from <math>-20^\circ / +70^\circ \text{ C}</math></li> </ul> | <p><b>Semi-conductive polystyrene = PS</b></p> <ul style="list-style-type: none"> <li>• Surface resistance <math>10^3 - 10^6 \Omega</math></li> <li>• Throughput <math>10^3 - 10^6 \Omega</math></li> <li>• Temperature resistance from <math>-40^\circ / +55^\circ \text{ C}</math></li> </ul> |



# The ESD control plan

**The ESD control plan determines how valuable and sensitive components and parts are protected from ESD damage, to set their own ESD limits, if necessary, and to establish a testing schedule for ESD materials.** The ESD monitoring plan is the starting point for static electricity management and is one of the issues defined by IEC 61340-5-1.

The ESD Standard provides certain thresholds, and with your control plan you can set the level you want above or below the standard, depending on how sensitive your components are and what your needs are. The ESD control plan will usually also include information about the selected grounding system and method. The control plan shall also describe ESD products such as desks and trolleys, as well as maintenance, servicing and cleaning measures. An ESD control plan is a written plan of how components are handled during storage, transfer and packaging. Also note that employees must be well trained and informed about the ESD control plan and how it is implemented at your workplace. Everyone needs to know why the plan has been made, what it contains and how the ESD Protected Area (EPA) should work. Everyone needs to understand the importance of static electricity management and its implications for product quality, cost, and, ultimately, customer satisfaction. It is a good idea to make the ESD control plan part of your company's quality system so that everyone in your company understands its importance.

Setting up an ESD environment is simple and straightforward. An ESD-protected area can be small, for example, one workbench, or it can be large, with hundreds of workbenches. However, both areas need the same procedures, only the scale is different. Everything starts with the ESD control plan. Then you just need to roll up your sleeves and start implementing the plan, beginning with the floor and the common point ground, moving to ergonomic and ESD-protected furniture, personnel and, finally, cleaning and maintenance with measurements. If possible, it is a good idea to optimize the EPA layout so that the movement of sensitive components from bench to bench is minimized. Then you are ready to work on any type of ESD sensitive components without any problems.

No matter whether you are a component producer, electronics manufacturer or only occasionally work on sensitive electronic components, it is important to have ESD protection in place. Investing in ESD protection usually pays back in terms of both money and brand. If your products are long lasting and reliable they are usually also appreciated by your customer.



# Colour codes

All the steel parts are light grey RAL 7035 and have a semi-conductive paint film. The semi-conductive powder coating we use is based on epoxy and polyester resin, which at elevated temperatures melts, cures and forms a semi-conductive paint film. This powder coating is developed especially for the ESD-protected areas (EPA). In addition, the paint film has excellent mechanical properties, i.e. abrasion and impact resistance and elasticity. It is not scratched easily and withstands action by chemicals, greases and solvents.

The products with colour code 49 (RAL 7035) are entirely ESD-protected: all the steel parts have a semi-conductive

paint film, castors, mats and bench tops are all made of semi-conductive materials. Please note that the semi-conductive powder coating RAL 7035 has a slightly darker shade of colour than the given RAL code.



**The colour code is included in those product codes that are formed with numbers.**

It is either at the end, following the hyphen (e.g. 860 804-49), or in the middle (e.g. C 334 49 000).



# Our standards comply with the highest certification requirements



|  |   |  |
|--|---|--|
| <p><b>Quality certification</b></p> <p>ISO 9001 : 2015</p> | <p><b>ESD-approval certification</b></p> <p>Our ESD products fulfill the basic requirements of IEC 61340-5-1.</p> | <p><b>Cleanroom Suitability of Treston Concept and WB Motorized Workstations</b></p> <p>ISO 14644-1, class 7</p> |
|--|---|--|



|   |  |   |
|---|--|---|
| <p><b>Cleanroom Suitability of Chair Treston Ergo C20PU-ESD</b></p> <p>ISO 14644-1, class 7</p> | <p><b>ESD certification</b></p> <p>Treston WB and Concept workstations fulfill the basic requirements of IEC 61340-5-1</p> | <p><b>ESD certification</b></p> <p>Treston shelf, stacking, storage and picking bins and storage cabinets fulfill the basic requirements of IEC61340-5-1.</p> |
|---|--|---|

To obtain a copy of our certificates, please contact [info@treston.com](mailto:info@treston.com).

## TRESTON WARRANTY PERIOD



**The guarantee period for Treston™ products is 10 years from the date of delivery with some exceptions.**

For plastic bins guarantee is 5 years. The warranty period for worksurfaces, electric components, saddle chairs, lights, and normal wear and tear items such as castors, slides and roll profiles is 2 years. For trading products and components as well as custom-made articles we guarantee 2-year warranty unless otherwise agreed.



# Workbenches

## Concept workbench, page 14

- Multiple bench variations with advanced ergonomic features
- Perfectly suitable for assembly, quality control or packing environments
- Highly adaptable to various applications and to the needs of the user
- Superior range of accessories, easily reconfigured
- Excellent stability, suitable for heavy loads up to 500 kg



500 kg



## WB workbench, page 18

- Aesthetic, ergonomic and easily adaptable to a large variety of tasks and environments
- Designed for the needs of R&D, electronics assembly and testing
- Extensive range of accessories to meet any need. Various layout possibilities from back-to-back to corner solutions
- Maximum load capacity 300 kg



300 kg



## Treston QuatreX workbench, page 20

- Electrical workbench specifically designed to offer supreme stability, flexibility, and precision
- Meets the needs of various industries and segments, including luxury goods manufacturing, electronics manufacturing, fine mechanics, logistics, and maintenance
- Flexibility and versatility – choose perforated or aluminium uprights
- Maximum load capacity 300 kg



300 kg



## TED electric desk, page 22

- TED Electric Desk comes with quick, silent and wide height adjustment
- This ergonomic sit-stand desk perfectly suits light-duty assembly work, packing applications, R&D and industrial offices
- The desk can be customized with accessories which further enhance ergonomics, free desk space and provide order
- The table withstands load of 200 kg



200 kg



## Quick Edge workstation, page 24

- The quickest height adjustment on the market - no electricity needed
- Can be customised for various operating environments
- Multiple accessories available: swivel arms for tool holders and screens, LED lights, shelves with dividers for cartons
- Maximum load capacity 100 kg



100 kg



## TP workbench, page 25

- Standard and cost-effective workbench
- Suitable for a wide range of tasks and environments
- Superior range of accessories, easily reconfigured
- Steel frame with loading capacity up to 300 kg



300 kg



## TPH workbench, page 27

- Standard and cost-effective workbench with one shelf
- Suitable for a wide range of tasks and environments
- Essential range of accessories for basic needs
- Steel frame with loading capacity up to 300 kg



300 kg



# Concept - the most versatile workbench

- Select the bench frame and the height adjustment method: allen key, hand crank or electric.
- Select a bench top to suit the frame.

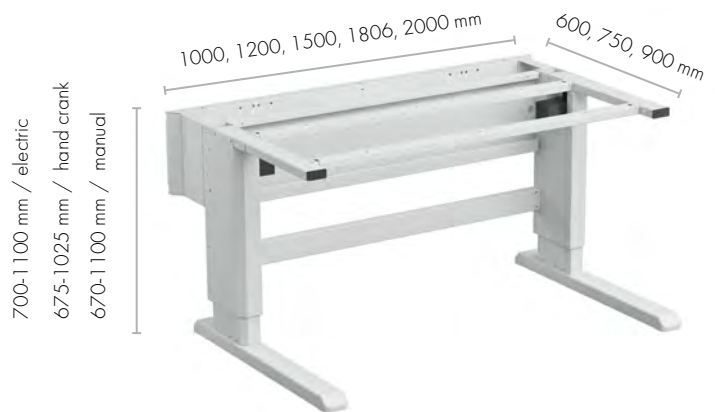

## Concept workbench frame

| Workbench frame size<br>W x D mm      | Bench frame,<br>allen key adjustable<br><b>Code ESD</b> | Bench frame<br>max load kg | Bench frame,<br>hand crank adjustable<br><b>Code ESD</b> | Bench frame<br>max load kg | Bench frame,<br>electric adjustable<br><b>Code ESD</b>  | Bench frame<br>max load kg |
|---------------------------------------|---|----------------------------|--|----------------------------|---|----------------------------|
| 1000 x 600                            | 100 49 015P   | 500                        | 101 49 015   | 200                        | 103 49 015P   | 400                        |
| 1000 x 750                            | 100 49 030P   | 500                        | 101 49 030   | 200                        | 103 49 030P   | 400                        |
| 1000 x 900                            | 100 49 062P   | 500                        | 101 49 062   | 200                        | 103 49 062P   | 400                        |
| 1200 x 600                            | 100 49 016P   | 500                        | 101 49 016   | 200                        | 103 49 016P   | 400                        |
| 1200 x 750                            | 100 49 031P   | 500                        | 101 49 031   | 200                        | 103 49 031P   | 400                        |
| 1200 x 900                            | 100 49 063P   | 500                        | 101 49 063   | 200                        | 103 49 063P   | 400                        |
| 1500 x 600                            | 100 49 017P   | 500                        | 101 49 017   | 200                        | 103 49 017P   | 400                        |
| 1500 x 750                            | 100 49 032P   | 500                        | 101 49 032   | 200                        | 103 49 032P   | 400                        |
| 1500 x 900                            | 100 49 064P   | 500                        | 101 49 064   | 200                        | 103 49 064P   | 400                        |
| 1800 x 600                            | 100 49 018P   | 500                        | 101 49 018   | 200                        | 103 49 018P   | 400                        |
| 1800 x 750                            | 100 49 033P   | 500                        | 101 49 033   | 200                        | 103 49 033P   | 400                        |
| 1800 x 900                            | 100 49 065P   | 500                        | 101 49 065   | 200                        | 103 49 065P   | 400                        |
| 2000 x 600                            | 100 49 019P   | 500                        |  |                            | 103 49 019P   | 400                        |
| 2000 x 750                            | 100 49 034P   | 500                        |  |                            | 103 49 034P   | 400                        |
| 2000 x 900                            | 100 49 066P   | 500                        |  |                            | 103 49 066P   | 400                        |
| Bench height<br>steplessly adjustable | 670 - 1100 mm   |                            | 675 - 1025 mm  |                            | 700 - 1100 mm<br>Height adjustment speed 13 mm / second |                            |

## Concept bench tops

| Size W x D mm | Code ESD    |
|---------------|-------------|
| 1000 x 600    | TT10060-ESD |
| 1000 x 750    | TT10075-ESD |
| 1000 x 900    | TT10090-ESD |
| 1030 x 750    | TT10375-ESD |
| 1030 x 900    | TT10390-ESD |
| 1200 x 600    | TT12060-ESD |
| 1200 x 750    | TT12075-ESD |
| 1200 x 900    | TT12090-ESD |
| 1230 x 750    | TT12375-ESD |
| 1230 x 900    | TT12390-ESD |
| 1500 x 600    | TT15060-ESD |
| 1500 x 750    | TT15075-ESD |
| 1500 x 900    | TT15090-ESD |
| 1530 x 750    | TT15375-ESD |
| 1530 x 900    | TT15390-ESD |
| 1806 x 600    | TT18060-ESD |
| 1806 x 750    | TT18075-ESD |
| 1806 x 900    | TT18090-ESD |
| 1836 x 750    | TT18375-ESD |
| 1836 x 900    | TT18390-ESD |
| 2000 x 600    | TT20060-ESD |
| 2000 x 750    | TT20075-ESD |
| 2000 x 900    | TT20090-ESD |
| 2030 x 750    | TT20375-ESD |
| 2030 x 900    | TT20390-ESD |



### ESD bench top

- Light grey laminate surface
- Grey edging
- Thickness 25 mm
- Semi-conductive (ESD)



**The Concept bench can be equipped with castors!**

**Castor set Ø100, Code ESD 860 429-00.**  
Load capacity with castors 300 kg. Always adjust the bench with castors to the lowest position when the bench is moved.



# Concept workbench examples

## Concept ESD workstation 1

| Qty | Name  | Size mm        | Code ESD     |
|-----|---|----------------|--------------|
| 1   | Electric adjustable bench frame             | 1500 x 750     | 103 49 032P  |
| 1   | Bench top ESD                               | 1500 x 750     | TT15075-ESD  |
| 2   | Cable duct                                  | M750           | 860 044-49   |
| 1   | Upright module, 1359 mm                     | 2 x M750       | UTM2X750M-49 |
| 1   | Light and balancer rail                     | 2 x M750       | 918 49 006P  |
| 1   | Steel shelf                                 | M750 x 300     | 836 028-49   |
| 1   | Perforated panel                            | M750 x 389     | 861 511-49   |
| 1   | Rotating tool panel frame with a double arm | 513 x 320      | 880 865-49   |
| 1   | Perforated panel for rotating tool frame    | M500           | 860 951-49   |
| 1   | Bin rail                                    | M750           | 859 151-49   |
| 7   | Stacking bin ESD                            | 105 x 165 x 75 | 1015-4ESD    |
| 1   | LCD screen holder with a double arm         |                | 930 49 002P  |
| 1   | Power rail                                  | M750           | TPR7-001     |
| 1   | Treston NaturLite LED                       | 1200           | TNL1200      |



## Concept ESD workstation 2

| Qty | Name                             | Size mm         | Code ESD     |
|-----|----------------------------------|-----------------|--------------|
| 1   | Allen key adjustable bench frame | 1500 x 750      | 100 49 032P  |
| 1   | Bench top ESD                    | 1500 x 750      | TT15075-ESD  |
| 1   | Upright module, 1359 mm          | 2 x M750        | UTM2X750M-49 |
| 1   | Light and balancer rail          | 2 x M750        | 918 49 006P  |
| 1   | Treston NaturLite LED            | 1200            | TNL1200      |
| 1   | Perforated panel                 | M750 x 612      | 861 512-49   |
| 1   | Power rail                       | M750            | TPR7-001     |
| 2   | Steel shelf                      | M750 x 300      | 836 028-49   |
| 1   | Drawer unit 30/15                | 300 x 454 x 150 | 859 330-49   |
| 1   | Fastening set                    |                 | 890 653-49   |



## Concept ESD workstation 3

| Qty | Name                              | Size mm        | Code ESD     |
|-----|-----------------------------------|----------------|--------------|
| 1   | Electric adjustable bench frame   | 1500 x 750     | 103 49 032P  |
| 1   | Bench top ESD                     | 1500 x 750     | TT15075-ESD  |
| 1   | Upright module, 1359 mm           | 2 x M750       | UTM2X750M-49 |
| 1   | Light and balancer rail           | 2 x M750       | 918 49 006   |
| 1   | Treston NaturLite LED             | 1200           | TNL1200      |
| 1   | Perforated panel                  | M750 x 389     | 861 511-49   |
| 1   | Steel shelf                       | M750 x 300     | 836 028-49   |
| 2   | Bin rail                          | M750           | 859 151-49   |
| 14  | Stacking bin ESD                  | 105 x 165 x 75 | 1015-4ESD    |
| 1   | Curved bin rail with a double arm | 770 x 54       | 929 49 002P  |
| 1   | Extension for curved bin rail     | 770 x 54       | 860 911-49   |
| 10  | Picking bin ESD                   | 99 x 160 x 70  | 30-1L-4ESD   |



**Concept ESD workstation 4**

| Qty | Name                             | Size mm    | Code ESD     |
|-----|----------------------------------|------------|--------------|
| 1   | Allen key adjustable bench frame | 1800 x 750 | 100 49 033P  |
| 1   | ESD bench top                    | 1806 x 750 | TT18075-ESD  |
| 1   | Upright module, 1359 mm          | 2 x M900   | UTM2X900M-49 |
| 1   | Light/balancer rail              | 2 x M900   | 918 49 008P  |
| 1   | Treston NaturLite LED            | 1200       | TNL1200      |
| 4   | Steel shelf                      | M900 x 300 | 852 283-49   |
| 2   | Power rail                       | M900       | TPR9-001     |
| 1   | Accessory bar                    | 1800       | 860 089-49   |
| 1   | Footrest, bar                    | 550 x 350  | 860 136-49   |

**Concept ESD workstation 5**

| Qty | Name                              | Size               | Code ESD     |
|-----|-----------------------------------|--------------------|--------------|
| 1   | Allen key adjustable bench frame  | 1800 x 750         | 100 49 033P  |
| 1   | ESD bench top                     | 1806 x 750         | TT18075-ESD  |
| 1   | Upright module, 1359 mm           | 2 x M900           | UTM2X900M-49 |
| 2   | Cable duct                        | M900               | 860 045-49   |
| 1   | Light/balancer rail               | 2 x M900           | 918 49 008P  |
| 1   | Treston NaturLite LED             | 1200               | TNL1200      |
| 2   | Steel shelf                       | M900 x 400         | 852 769-49   |
| 2   | Power rail                        | M900               | TPR9-001     |
| 1   | LCD screen holder with double arm |                    | 930 49 002P  |
| 1   | Accessory bar                     | 1800               | 860 089-49   |
| 1   | Footrest, bar                     | 550 x 350          | 860 136-49   |
| 1   | CPU holder for Concept table      | 180-225 x 450 x 50 | 860 552-49   |
| 1   | Drawer unit 30/15                 | 300 x 454 x 150    | 859 330-49   |
| 1   | Fastening set                     |                    | 890 653-49   |

**Concept ESD workstation 6**

| Qty | Name   | Size mm         | Code ESD     |
|-----|--|-----------------|--------------|
| 1   | Allen key adjustable bench frame               | 1500 x 750      | 100 49 032P  |
| 1   | ESD bench top                                  | 1500 x 750      | TT15075-ESD  |
| 1   | Upright tube module, 1359 mm                   | 2 x M750        | UTM2X750M-49 |
| 1   | Light and balancer rail                        | 2 x M750        | 918 49 006P  |
| 1   | Steel shelf                                    | M750 x 300      | 836 028-49   |
| 1   | Steel shelf                                    | M750 x 400      | 852 770-49   |
| 1   | Divider pair                                   | 385 x 190       | 010 005-49   |
| 1   | Bin rail                                       | M750            | 859 151-49   |
| 1   | LCD screen holder with a double arm            |                 | 930 49 002P  |
| 1   | Keyboard tray for LCD holder                   | 480 x 260       | 860 941-49   |
| 1   | Drawer unit 30/22 with an electronic code lock | 300 x 454 x 220 | 720 010-49   |
| 1   | Fastening set                                  |                 | 890 653-49   |
| 1   | Accessory bar                                  | 1500            | 860 088-49   |
| 1   | CPU holder for accessory bar                   | 150 x 500 x 85  | 860 551-49   |
| 1   | Treston NaturLite LED                          | 1200            | TNL1200      |
| 2   | Perforated panel                               | M750 x 1003     | 861 514-49   |



# Concept extension benches

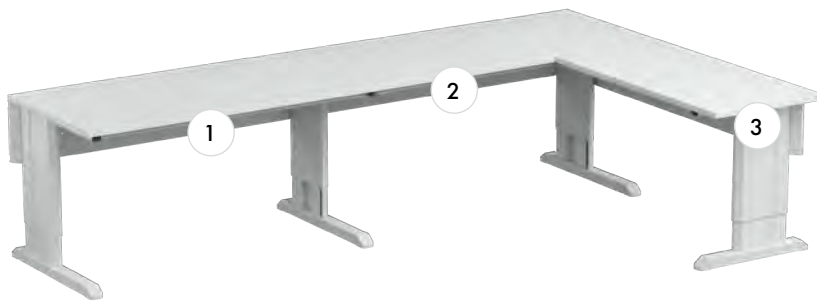

- 1. Workbench frame,
- 2. Extension bench frame
- 3. Corner bench frame

### Concept extension bench frame (right)

| Name                  | Size<br>W x D mm | Max<br>load kg | Code ESD    |
|-----------------------|------------------|----------------|-------------|
| Extension bench frame | 1500 x 600       | 250            | 112 49 001P |
| Extension bench frame | 1500 x 750       | 250            | 112 49 002P |
| Extension bench frame | 1800 x 750       | 250            | 112 49 003P |
| Extension bench frame | 1500 x 900       | 250            | 112 49 007P |
| Extension bench frame | 1800 x 900       | 250            | 112 49 008P |

### Concept corner bench frame (right)

| Name  | Size<br>W x D mm | Max<br>load kg | Code ESD    |
|---|------------------|----------------|-------------|
| Corner bench frame for allen key adjustable bench 600 mm deep | 1000 x 600       | 250            | 111 49 001P |
| Corner bench frame for allen key adjustable bench 750 mm deep | 1200 x 600       | 250            | 111 49 002P |

### Concept extension bench frame (left)

| Name                  | Size<br>W x D mm | Max<br>load kg | Code ESD    |
|-----------------------|------------------|----------------|-------------|
| Extension bench frame | 1500 x 600       | 250            | 112 49 004P |
| Extension bench frame | 1500 x 750       | 250            | 112 49 005P |
| Extension bench frame | 1800 x 750       | 250            | 112 49 006P |
| Extension bench frame | 1500 x 900       | 250            | 112 49 009P |
| Extension bench frame | 1800 x 900       | 250            | 112 49 010P |

### Concept corner bench frame (left)

| Name  | Size<br>W x D mm | Max<br>load kg | Code ESD    |
|---|------------------|----------------|-------------|
| Corner bench frame for allen key adjustable bench 600 mm deep | 1000 x 600       | 250            | 111 49 003P |
| Corner bench frame for allen key adjustable bench 750 mm deep | 1200 x 600       | 250            | 111 49 004P |

## Battery set for Concept motor adjustable frames and TED electric desks

The smaller sized Concept and TED workbenches equipped with castors, electric height adjustment, and battery set are an excellent option for workspaces where you need a compact size, easily height adjustable, and mobile work surface. You get all the ergonomic benefits of easy, electric height adjustment, and freedom of mobility with the battery set – no need to worry if the power cables are long enough for moving the work surface around the workspace.

| Name  | Code   |
|---|--------|
| Battery set   | BSC001 |
| Suitable for Concept motor adjustable frames and TED electric desks. Battery set sold only to EU countries. |        |
| <b>Note: Battery set is not ESD certified.</b>  |        |



All non ESD certified accessories are EPA –compatible when their combination of the potential charge level and physical distance to the ESDS –related parts is managed by ESD standard IEC 61340-5-1



Watch this [animation](#) showcasing the versatile usage options



# WB - aesthetic and easily adaptable

- Select the height adjustment method: allen key, electric or crank.
- Stepless height adjustment between 700-1100 mm.

### WB allen key adjustable bench

| Bench size W x D mm | Max load kg | Code ESD  |
|---------------------|-------------|-----------|
| 1073 x 800          | 300         | WB811 ESD |
| 1500 x 800          | 300         | WB815 ESD |
| 1800 x 800          | 300         | WB818 ESD |

We recommend using the cable tidy WBCT with WB Allen-key adjustable benches (page 41).

### WB electric adjustable bench

| Bench size W x D mm | Max load kg | Code ESD      |
|---------------------|-------------|---------------|
| 1073 x 800          | 300         | WB811 EL ESD  |
| 1500 x 800          | 300         | WB 815 EL ESD |
| 1800 x 800          | 300         | WB818 EL ESD  |

Height adjustment speed 20 mm/ second.

Cable tidy as standard.

### WB crank adjustable bench

| Bench size W x D mm | Max load kg | Code ESD    |
|---------------------|-------------|-------------|
| 1073 x 800          | 200         | WB811 C ESD |
| 1500 x 800          | 200         | WB815 C ESD |
| 1800 x 800          | 200         | WB818 C ESD |

Cable tidy as standard.



WB electric adjustable bench has a desk panel with memory function



### ESD bench top

- Light grey laminate surface
- Grey edging
- Thickness 25 mm
- Semi-conductive (ESD)

### The WB bench can be equipped with castors!

Castor set Ø100, Code ESD LCS100 ESD

Load capacity with castors is the same as the bench loading capacity with adjustable screws. We recommend using the cable tidy WBCT with WB Allen-key adjustable benches. Always adjust the bench with castors to the lowest position when the bench is moved.



# WB workbench examples

## WB ESD workstation 1

| Qty | Name                         | Size mm                  | Code ESD     |
|-----|------------------------------|--------------------------|--------------|
| 1   | WB workbench EL ESD          | 1500 x 800               | WB815 EL ESD |
| 1   | Accessory frame              | 690 x 500 +<br>690 x 500 | AKK150       |
| 1   | Upright profile              | 1489 x 900               | AL2X150W     |
| 1   | Support bracket              |                          | HSB150       |
| 1   | Treston NaturLite LED        | 1200                     | TNL1200      |
| 1   | Shelf                        | 1500 x 310               | ALH150 ESD   |
| 1   | Perforated panel             | 668 x 500                | ARL70        |
| 1   | Bin profile                  | 685                      | BP70         |
| 1   | Light steel cabinet, 2 x 100 | 370 x 460 x 245          | LMC02 ESD    |
| 1   | Cover for LMC                |                          | LMCK2        |



## WB ESD workstation 2

| Qty | Name                           | Size mm         | Code ESD     |
|-----|--------------------------------|-----------------|--------------|
| 1   | WB electric adjustable bench   | 1037 x 800      | WB811 EL ESD |
| 1   | Castor set                     | Ø 100           | LCS100 ESD   |
| 1   | Upright profile                | 1063 x 900      | AL2X110W     |
| 1   | LCD bracket                    |                 | MH           |
| 1   | Bin profile                    | 985             | BP100 ESD    |
| 1   | Auxiliary steel shelf A5       | 159 x 210       | ASSA5        |
| 2   | Treston NaturLite Led Wing 500 | 500             | TNL500W      |
| 1   | Light steel cabinet            | 370 x 460 x 135 | LMC01 ESD    |
| 1   | Cover                          |                 | LMCK2        |



## WB ESD workstation 3

| Qty | Name                         | Size mm                  | Code ESD     |
|-----|------------------------------|--------------------------|--------------|
| 1   | WB electric adjustable bench | 1800 x 800               | WB818 EL ESD |
| 1   | Earthing box ESD             |                          | J6603        |
| 1   | Upright profile              | 1789 x 900               | AL2X180W     |
| 1   | Support bracket              | 1800                     | HSB180       |
| 1   | Treston NaturLite Led        | 1200                     | TNL1200      |
| 1   | Shelf                        | 1800 x 310               | ALH180 ESD   |
| 1   | Accessory frame AKK ESD      | 690 x 500 +<br>990 x 500 | AKK180       |
| 1   | Perforated panel ESD         | 668 x 500                | ARL70        |
| 2   | Bin profile ESD              | 985                      | BP100 ESD    |
| 2   | Auxiliary steel shelf A5     | 159 x 210                | ASSA5        |
| 1   | Swivel arm with tray         | 460 x 210                | AKV400 ESD   |
| 1   | LCD swivel arm               |                          | MA           |
| 1   | Light steel cabinet          | 370 x 460 x 245          | LMC02 ESD    |
| 1   | Cover                        |                          | LMCK2        |
| 1   | Magnifying lamp Wave LED ESD |                          | TWL ESD      |



Watch this [animation](#) showcasing the versatile usage options

# Designing Treston QuatreX workstation

- Select the bench frame and add ESD grounding set
- Select a bench top to suit the frame

**+** **Accessories from page 29 and 42**  
 QuatreX is the first Treston workbench to utilize both upright tubes, and aluminium upright profiles, offering more flexibility in workstation setup.



## Treston QuatreX bench frame

| Name                                  | Size<br>W x D mm | Max<br>load kg | Code       |
|---------------------------------------|------------------|----------------|------------|
| Four-leg electric bench frame         | 1025 x 750       | 300            | QX10375-41 |
| Four-leg electric bench frame         | 1225 x 750       | 300            | QX12375-41 |
| Four-leg electric bench frame         | 1525 x 750       | 300            | QX15375-41 |
| Four-leg electric bench frame         | 1825 x 750       | 300            | QX18375-41 |
| Four-leg electric bench frame         | 2025 x 750       | 300            | QX20375-41 |
| Four-leg electric bench frame         | 1025 x 900       | 300            | QX10390-41 |
| Four-leg electric bench frame         | 1225 x 900       | 300            | QX12390-41 |
| Four-leg electric bench frame         | 1525 x 900       | 300            | QX15390-41 |
| Four-leg electric bench frame         | 1825 x 900       | 300            | QX18390-41 |
| Four-leg electric bench frame         | 2025 x 900       | 300            | QX20390-41 |
| ESD Grounding set for Treston QuatreX |                  |                | QX-ESD     |

## Treston QuatreX bench tops

| Size<br>W x D mm | Code<br>ESD |
|------------------|-------------|
| 1030 x 750       | TT10375-ESD |
| 1030 x 900       | TT10390-ESD |
| 1230 x 750       | TT12375-ESD |
| 1230 x 900       | TT12390-ESD |
| 1530 x 750       | TT15375-ESD |
| 1530 x 900       | TT15390-ESD |
| 1836 x 750       | TT18375-ESD |
| 1836 x 900       | TT18390-ESD |
| 2030 x 750       | TT20375-ESD |
| 2030 x 900       | TT20390-ESD |

## Side plates

| Name                            | Size mm   | Code       |
|---------------------------------|-----------|------------|
| Side plates for Treston QuatreX | depth 750 | SPQX750-49 |
| Side plates for Treston QuatreX | depth 900 | SPQX900-49 |

The optional side plates, available as an accessory, ensure a safe environment when two tables are used side by side. Includes two plates, right hand and left hand versions.



**ESD bench top**

- Light grey laminate surface
- Grey edging
- Thickness 25 mm
- Semi-conductive (ESD)

## Battery set

| Name        | Code   |
|-------------|--------|
| Battery set | BSC001 |

Suitable for Concept motor adjustable frames, Treston QuatreX and TED electric desks. Battery set sold only to EU countries.

**Note: Battery set is not ESD certified.**



## The QuatreX bench can be equipped with castors!

**Castor set Ø100**, code LCS100 ESD

Load capacity with castors 300 kg. Always adjust the bench with castors to the lowest position when the bench is moved.



# Treston QuatreX workbench examples

## Treston QuatreX ESD workstation 1

| Qty | Name   | Size mm         | Code ESD    |
|-----|--|-----------------|-------------|
| 1   | QuatreX electric bench frame   | 1525 x 750      | QX15375-41  |
| 1   | ESD bench top  | 1530 x 750      | TT15375-ESD |
| 1   | ESD grounding set  |                 | QX-ESD      |
| 1   | Upright profiles   | 1489 x 1200     | AL2X150GX   |
| 1   | Accessory frame  |                 | AKK150      |
| 1   | Support bracket  | 1500            | HSB150      |
| 1   | Shelf  | 1500 x 310      | ALH150 ESD  |
| 1   | Treston NaturLite Led Plus   | 1200            | TNL1200P    |
| 2   | Perforated panel   | 668 x 500       | ARL70       |
| 1   | Small-parts storage cabinet  | 310 x 180 x 290 | 291-4ESD    |
| 1   | Bracket for fixing small plastic storage cabinet to perforated panel |                 | 890 535-51  |
| 1   | LCD swivel arm   |                 | MA          |
| 1   | Power rail   | 683             | TPR7-001    |
| 1   | Swivel arm with tray   | 460 x 210       | AKV400 ESD  |



## Treston QuatreX ESD workstation 2

| Qty | Name                         | Size mm     | Code ESD    |
|-----|------------------------------|-------------|-------------|
| 1   | QuatreX electric bench frame | 1525 x 750  | QX12375-41  |
| 1   | ESD bench top                | 1530 x 750  | TT12375-ESD |
| 1   | ESD grounding set            |             | QX-ESD      |
| 1   | Upright profiles             | 1489 x 1200 | AL2X110GX   |
| 1   | Support bracket              | 1500        | HSB110      |
| 1   | Shelf                        | 1500 x 310  | ALH150 ESD  |
| 1   | Treston NaturLite Led Plus   | 1200        | TLN900      |
| 1   | Bin profile                  | 985         | BP100 ESD   |



## Treston QuatreX ESD workstation 3

| Qty | Name                                     | Size mm         | Code ESD     |
|-----|--|-----------------|--------------|
| 1   | QuatreX electric bench frame             | 1525 x 750      | QX15375-41   |
| 1   | ESD bench top                            | 1530 x 750      | TT15375-ESD  |
| 1   | ESD grounding set                        |                 | QX-ESD       |
| 1   | Upright tube module, 1359 mm             | 2 x M750        | UTM2X750M-49 |
| 3   | Steel shelf                              | M750 x 300      | 836028-49    |
| 1   | Perforated panel                         | M750 x 612      | 861512-49    |
| 1   | Power rail                               | 683             | TPR7-001     |
| 1   | Light and balancer rail                  | 2 x M750        | 91849006P    |
| 1   | Drawer unit 45/14-1                      | 450 x 520 x 140 | 60349001     |
| 1   | Drawer unit 45 fastening set for Quatrex |                 | 855058-49    |
| 1   | Treston NaturLite Led                    | 1200            | TNL1200      |



Watch the feature showcase [video](#)



# TED - electric desk for industrial use

- TED desk consists of the frame and the bench top.
- Quick, silent and wide height adjustment 630-1270 mm (range 64 cm)



## TED Electric Desk

| Bench size W x D mm | Module | Max load kg | Code ESD  |
|---------------------|--------|-------------|-----------|
| 900 x 800           | M750   | 200         | TED809-49 |
| 1100 x 800          | M900   | 200         | TED811-49 |
| 1500 x 800          | M1350  | 200         | TED815-49 |
| 1800 x 800          | M1500  | 200         | TED818-49 |

Height adjustment speed 22 mm / second



### TED desk can be equipped with castors!

**Castor set Ø100 ESD** Code LCS100 ESD  
Always adjust the bench with castors to the lowest position when the bench is moved.



### ESD bench top

- Light grey laminate surface
- Grey edging
- Thickness 25 mm
- Semi-conductive (ESD)

## Upright Tube Pair with a flange

| Size W x D x H mm | Code ESD  |
|-------------------|-----------|
| 70 x 100 x 418    | TTP400-49 |
| 70 x 100 x 793    | TTP790-49 |
| 70 x 100 x 997    | TTP990-49 |

Treston upright tubes enable TED electric desk to be accessorised in many ways. Fitted on worktop with screws.



## Lower shelf for TED desk

| Size W x D mm                       | Suitable for            | Max load kg | Code ESD   |
|-------------------------------------|-------------------------|-------------|------------|
| 465 x 400                           | All TED benches         | 60          | LST500-49  |
| 715 x 400                           | TED811, TED,815, TED818 | 60          | LST750-49  |
| 865 x 400                           | TED815, TED818          | 60          | LST900-49  |
| 965 x 400                           | TED815, TED818          | 60          | LST1000-49 |
| 1165 x 400                          | TED818                  | 60          | LST1200-49 |
| 1315 x 400                          | TED818                  | 60          | LST1350-49 |
| Divider hoops set (4 pcs) 400 x 400 |                         |             | PDH400-49  |

Includes back lip. Fitted under worktop with screws. The lower shelf can also be equipped with divider hoops.



# TED desk examples

## TED ESD workstation 1

| Qty | Name                                   | Size mm    | Code ESD   |
|-----|--|------------|------------|
| 1   | Treston Electric Desk                  | 1500 x 800 | TED815-49  |
| 1   | Upright Tube Pair with a flange        | 400        | TTP400-49  |
| 2   | Treston Display Bracket for light duty |            | TDB-49     |
| 1   | Drawer unit ESD 30/22                  |            | 859 340-49 |
| 1   | Drawer unit 30 fastening set for TED   |            | 855 057-49 |
| 1   | Bottle holder ESD for upright tube     | Ø100       | 859 063-49 |



## TED ESD workstation 2

| Qty | Name                                       | Size mm    | Code ESD    |
|-----|--|------------|-------------|
| 1   | Treston Electric Desk                      | 1100 x 800 | TED811-49   |
| 1   | Upright Tube Pair with a flange            | 790        | TTP790-49   |
| 1   | Perforated back panel                      | M900       | 861 516-49  |
| 1   | LCD monitor holder for perforated panel    |            | 890 715-49  |
| 2   | Treston NaturLite Led Wing 500             |            | TNL500W     |
| 2   | Auxiliary steel shelf for perforated panel | 159 x 210  | ASSA5PP     |
| 1   | Bottle holder ESD for upright tube         | Ø100       | 859 063-49  |
| 1   | Laptop/printer shelf ESD                   | 365 x 365  | 930 49 001P |
| 1   | Cable clip set for upright tubes           |            | CC5         |
| 1   | Power rail                                 | 836        | TPR9-010    |



## TED ESD workstation 3

| Qty | Name                                   | Size mm    | Code ESD    |
|-----|--|------------|-------------|
| 1   | Treston Electric Desk ESD              | 1500 x 800 | TED815-49   |
| 1   | Upright Tube Pair with a flange        | 790        | TTP790-49   |
| 1   | Light and balancer rail ESD            |            | 918 49 011P |
| 1   | Treston IntoLite Led                   | 850        | TIL850      |
| 1   | Perforated back panel                  | M1350      | 861 521-49  |
| 1   | Treston Display Bracket for light duty |            | TDB-49      |
| 1   | Curved bin rail ESD with arm           | 770 x 54   | 929 49 002P |
| 1   | Steel shelf ESD M1350                  | 1340 x 300 | 860 787-49  |
| 1   | Aluminium bin rail M1350               |            | BP1350C     |
| 2   | Auxiliary steel shelf                  | 159 x 210  | ASSA5       |
| 1   | Magnifying lamp Wave LED ESD           |            | TWL ESD     |
| 1   | Drawer unit ESD 30/15                  |            | 859 330-49  |
| 1   | Drawer unit 30 fastening set for TED   |            | 855 057-49  |
| 1   | Power rail                             | 836        | TPR9-010    |



Watch the 2 min [animation](#) showcasing the features

# Treston Quick Edge workstation - extremely fast height adjustment

- Quick Edge workstation consists of the frame, the bench top and upright profiles.
- Equip with M1200 wide accessories, swivel arms or printer platforms.
- Quick Edge workstation can be used in EPAs with grounding set TQE-ESD.

### Quick Edge workstation

| Size W x D mm | Module | Max load kg | Code       |
|---------------|--------|-------------|------------|
| 1200 x 700    | M1200  | 100*        | TQEW712-41 |

Static load capacity for bench top 100 kg, total load capacity for frame 300 kg.



The new, innovative, patent pending height adjustment solution minimises the height exchange time between handled items and makes daily work more fluent, efficient, and ergonomic. Bench top is adjusted without load due to the constant force springs as an adjustment mechanism.

### Grounding set for Treston Quick Edge workstation

| Name   | Code ESD |
|--|----------|
| Grounding set for Treston Quick Edge workstation | TQE-ESD  |

With this grounding set you can use Treston Quick Edge workstation in EPAs.



Grounding set for Treston Quick Edge workstation

### Spring set for Treston Quick Edge Workstation

| Name  | Code |
|---|------|
| Spring set for Treston Quick Edge Workstation | TQES |

Replace the constant force spring set at least after every 10 000 operating cycles.



Quick Edge workstation can be equipped with castors.

Castor set ESD Ø 100 Code LCS100 ESD

# TP - ideal basic workbench

- Stepless height adjustment with allen key between 650-900 mm.
- Upright tubes (ordered separately) allow to attach a wide range of accessories.



## TP workbench

| Bench size W x D mm | Max load kg | Code ESD  |
|---------------------|-------------|-----------|
| 700 x 500           | 150         | TP507 ESD |
| 1000 x 500          | 150         | TP510 ESD |
| 1500 x 500          | 150         | TP515 ESD |
| 1000 x 700          | 300         | TP710 ESD |
| 1200 x 700          | 300         | TP712 ESD |
| 1500 x 700          | 300         | TP715 ESD |
| 1800 x 700          | 300         | TP718 ESD |
| 1500 x 900          | 300         | TP915 ESD |
| 1800 x 900          | 300         | TP918 ESD |



### ESD bench top

- Light grey laminate surface
- Grey edging
- Thickness 25 mm
- Semi-conductive (ESD)

## Lower steel shelf LSS

| Name                            | Size W x D mm | Max load kg | Code ESD |
|---------------------------------|---------------|-------------|----------|
| Lower shelf                     | 1418 x 460    | 30          | LSS150   |
| Lower shelf                     | 1718 x 460    | 30          | LSS180   |
| Low M-divider hoops (4 pcs/set) | 460 x 315     |             | LDH      |

Hangs on the horizontal bars. Can be equipped with steplessly adjustable low M-divider hoops.



### The TP bench can be equipped with castors!

**Castor set Ø100**, code ESD 860 429 -00. Insert set (required to fit castors), code 853 289-00. Load capacity with castors 150 kg. We recommend using the fixing frame for the castors. Always adjust the bench with castors to the lowest position when the bench is moved.



TP extension benches also available!  
For more information please check our web site [www.treston.com](http://www.treston.com) or Main catalogue page 47.



# TP workbench examples

## TP workbench 1

| Qty | Name                | Size mm    | Code ESD     |
|-----|---------------------|------------|--------------|
| 1   | Workbench TP        | 1500 x 700 | TP715 ESD    |
| 1   | Accessory frame     | 1500       | TPK15-49     |
| 1   | Upright tube module | 2 x M750   | UTM2X750M-49 |



## TP workbench 2

| Qty | Name                      | Size mm    | Code ESD     |
|-----|---------------------------|------------|--------------|
| 1   | Workbench TP              | 1500 x 700 | TP715 ESD    |
| 1   | Accessory frame           | 1500       | TPK15-49     |
| 1   | Upright tube module       | 2 x M750   | UTM2X750M-49 |
| 1   | Light/balancer rail       | 2 x M750   | 918 49 006P  |
| 1   | Treston NaturLite LED1200 | 1180       | TNL1200      |
| 2   | Steel shelf               | M750 x 300 | 836 028-49   |
| 2   | Bin profile               | M750       | 859 151-49   |
| 10  | Stacking bin              |            | 1525-4ESD    |



## TP workbench 3

| Qty | Name                    | Size mm     | Code ESD      |
|-----|-------------------------|-------------|---------------|
| 1   | TP workbench            | 1200 x 700  | TP712 ESD     |
| 1   | Accessory frame         | 1200        | TPK12-49      |
| 1   | Upright tube module     | 1 x M1200   | UTM1X1200M-49 |
| 1   | Tilttable top shelf     | M1200 x 300 | TTSM12003-49  |
| 1   | Light and balancer rail | M1200       | 918 49 010P   |
| 1   | Treston IntoLite Led    | 850         | TIL850        |



Watch this [animation](#) showcasing the versatile usage options

# TPH - standard workbench with one shelf

- Stepless height adjustment with allen-key between 650-900 mm.
- Includes a pair of uprights and one shelf

## Workbench TPH

| Bench size<br>W x D mm | Shelf size<br>W x D mm | Max<br>load kg | Code ESD   |
|------------------------|------------------------|----------------|------------|
| 1200 x 700             | 1200 x 310             | 300            | TPH712 ESD |
| 1500 x 700             | 1500 x 310             | 300            | TPH715 ESD |
| 1800 x 700             | 1800 x 310             | 300            | TPH718 ESD |
| 1500 x 900             | 1500 x 310             | 300            | TPH915 ESD |
| 1800 x 900             | 1800 x 310             | 300            | TPH918 ESD |



### ESD bench top

- Light grey laminate surface
- Grey edging
- Thickness 25 mm
- Semi-conductive (ESD)

## Lower steel shelf LSS

| Name                               | Size W x D mm | Max load kg | Code   |
|------------------------------------|---------------|-------------|--------|
| Lower shelf                        | 1418 x 460    | 30          | LSS150 |
| Lower shelf                        | 1718 x 460    | 30          | LSS180 |
| Low M-divider hoops<br>(4 pcs/set) | 460 x 315     |             | LDH    |

Hangs on the horizontal bars. Can be equipped with steplessly adjustable low M-divider hoops.



## Corner workbench TPH KK

| Bench size W x D mm | Max load kg | Code ESD      |
|---------------------|-------------|---------------|
| 1100 x 1100         | 150         | TPH707 KK ESD |
| 1300 x 1300         | 150         | TPH909 KK ESD |

A corner workbench can be used with two TPH benches (with one H-frame pair) to create a 90 °angle setup. TPH KK unit consists of a worktop, two H-frames and a leg in the middle. Front side 565 mm.



\* Workbench with one H-frame pair.

# TPH workbench examples

## TPH workbench 1

| Qty | Name                        | Size mm         | Code ESD   |
|-----|-----------------------------|-----------------|------------|
| 1   | TPH workbench               | 1500 x 700      | TPH715 ESD |
| 1   | Auxiliary shelf             | 1500 x 310      | SH150 ESD  |
| 1   | Light steel cabinet, 2 x100 | 370 x 460 x 245 | LMC02 ESD  |



## TPH workbench 2

| Qty | Name                      | Size mm    | Code ESD   |
|-----|---------------------------|------------|------------|
| 1   | TPH workbench             | 1500 x 700 | TPH715 ESD |
| 1   | Tool and lighting support | 1500 x 600 | KT150      |
| 1   | Treston NaturLite LED     | 1200       | TNL1200    |



## TPH workbench 3

| Qty | Name                                | Size mm         | Code ESD   |
|-----|-------------------------------------|-----------------|------------|
| 1   | TPH workbench                       | 1500 x 700      | TPH715 ESD |
| 1   | Tool and lighting support           | 1500 x 600      | KT150      |
| 1   | Treston NaturLite LED               | 1200            | TNL1200    |
| 1   | Divider hoops set ESD, 5 pcs        | 400             | PDH        |
| 1   | Perforated panel                    | 1415 x 750      | RL150      |
| 1   | Perforated panel connectors for TPH |                 | RK1        |
| 1   | Swivel arm with tray                | 460 x 210       | CKV400 ESD |
| 1   | Component rack                      | 455 x 200       | EPL12 ESD  |
| 12  | Stacking bin, black ESD             | 105 x 165 x 75  | 1015-4ESD  |
| 1   | Drawer unit 45, 1x100               | 450 x 520 x 140 | 603 49 001 |



# ESD accessories for Concept, QuatreX, TED, Quick Edge and TP

Our Concept, QuatreX, TED, Quick Edge, and TP benches can be fitted with the same accessories and they are interchangeable. Upright tubes are the basic element for accessorising our industrial furnishings. Accessories are attached to Concept, QuatreX, TED and TP benches with the aid of upright tubes or a complete, upright tube module. The complete upright tube module includes upright tubes, horizontal profile, and fixing plugs.

For the Concept and QuatreX bench, the upright tubes are attached to the rear case of the bench with the fixing plates or screws that are delivered with the bench. With the TP bench, you also need an accessory frame TPK (page 30), which also includes the fixing plates for the upright tubes. For the TED bench, upright tube pair with a flange is fitted on worktop with screws.

## Upright tubes for Concept, QuatreX and TP

| Name                    | Size<br>W x D mm | Length (l)<br>mm | Code       |
|-------------------------|------------------|------------------|------------|
| Upright tube            | 30 x 60          | 500              | 860 991-49 |
| Upright tube            | 30 x 60          | 800              | 860 142-49 |
| Upright tube            | 30 x 60          | 996              | 860 367-49 |
| Upright tube            | 30 x 60          | 1359             | 860 024-49 |
| Upright tube            | 30 x 60          | 1582             | 860 025-49 |
| Horizontal profile      | M500             |                  | HPM500-49  |
| Horizontal profile      | M750             |                  | HPM750-49  |
| Horizontal profile      | M900             |                  | HPM900-49  |
| Horizontal profile      | M1000            |                  | HPM1000-49 |
| Horizontal profile      | M1200            |                  | HPM1200-49 |
| Horizontal profile      | M1350            |                  | HPM1350-49 |
| Horizontal profile      | M1500            |                  | HPM1500-49 |
| Horizontal profile      | M1800            |                  | HPM1800-49 |
| Horizontal profile      | M2000            |                  | HPM2000-49 |
| Fixing plug set (2 pcs) |                  |                  | FPSET      |

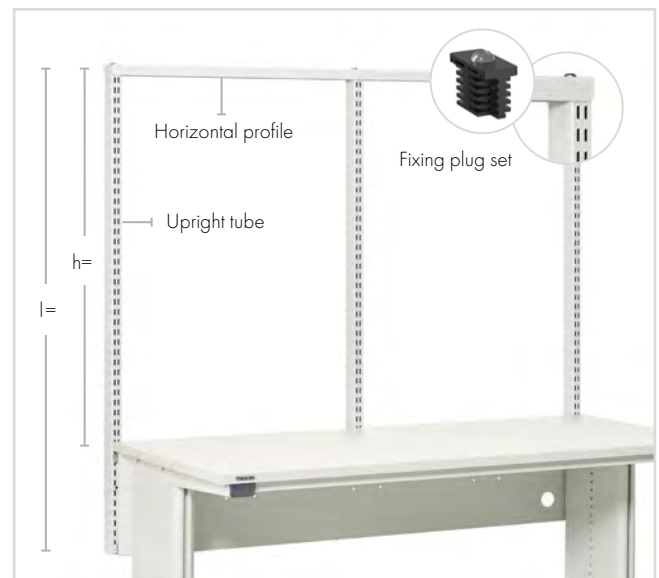

## Upright tube modules and compatibility

| Suitable for bench widths<br>C = Concept, TP = TP, Q = QuatreX |      |        |        |        |     | Code S                | Code M                  | Code L                  |
|--|------|--------|--------|--------|-----|-----------------------|-------------------------|-------------------------|
| 1000   | 1200 | 1500   | 1800   | 2000   |     | l=996 mm<br>h=683 mm* | l=1359 mm<br>h=1046 mm* | l=1582 mm<br>h=1269 mm* |
| 1 x M750   | C    | C/TP   | C      | C      | C   | UTM1X750S-49          | UTM1X750M-49            | UTM1X750L-49            |
| 1 x M900   | C/TP | C/TP   | C      | C      | C   | UTM1X900S-49          | UTM1X900M-49            | UTM1X900L-49            |
| 1 x M1200  |      | C/TP/Q |        |        |     | -                     | UTM1X1200M-49           | -                       |
| 1 x M1500  |      |        | C/TP/Q | C      | C   | -                     | UTM1X1500M-49           | -                       |
| 1 x M1800  |      |        |        | C/TP/Q | C/Q | -                     | UTM1X1800M-49           | -                       |
| 2 x M500   | C/Q  | C      |        |        |     | UTM2X500S-49          | UTM2X500M-49            | UTM2X500L-49            |
| 2 x M750   |      |        | C/TP/Q | C      | C   | UTM2X750S-49          | UTM2X750M-49            | UTM2X750L-49            |
| 2 x M900   |      |        |        | C/TP/Q | C/Q | UTM2X900S-49          | UTM2X900M-49            | UTM2X900L-49            |
| 3 x M500   |      |        | C/TP/Q | C      |     | UTM3X500S-49          | UTM3X500M-49            | UTM3X500L-49            |
| 4 x M500   |      |        |        |        | C/Q | UTM4X500S-49          | UTM4X500M-49            | UTM4X500L-49            |

\*h = module's height measured from bench's top surface.

Load capacity 100 kg / module spacing. With QuatreX the total load capacity of the upright structure is 150 kg.

Upright tube module includes upright tubes, horizontal profile, fixing plugs, and 5 pcs of cable clips for easy cable management.

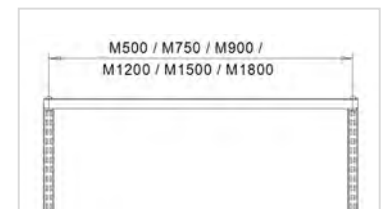

The modular (M) size refers to the distance between two upright tubes from the middle of the tube. The modular size is used to find the appropriate accessories.



**Accessory frame for TP bench**

| Bench frame width mm | Fixing points for uprights    | Code ESD |
|----------------------|-------------------------------|----------|
| 1000                 | 1 x M900, 1 x M1000           | TPK10-49 |
| 1200                 | 1 x M750, 1 x M900, 1 x M1200 | TPK12-49 |
| 1500                 | 1 x M1500, 2 x M750           | TPK15-49 |
| 1800                 | 1 x M1800, 2 x M900           | TPK18-49 |

Upright tubes or the upright tube module are always attached to TP bench with accessory frame. The accessory frame cannot be used on line or corner extensions.



**Accessory frame for TP bench**

**Upright Tube Pair with a flange for TED bench**

| Size W x D x H mm | Code ESD  |
|-------------------|-----------|
| 70 x 100 x 418    | TTP400-49 |
| 70 x 100 x 793    | TTP790-49 |
| 70 x 100 x 997    | TTP990-49 |

Treston upright tubes enable TED electric desk to be accessorised in many ways. Fitted on worktop with screws.

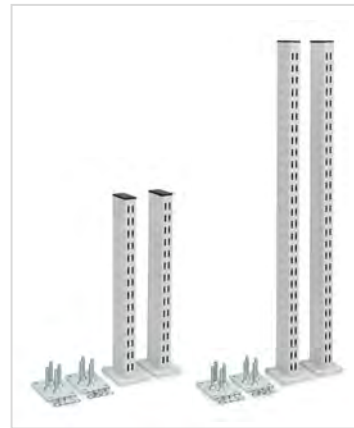

**Upright tube pair with a flange**



**Aluminium bracket**

**Aluminium bracket**

| Name              | Code ESD   |
|-------------------|------------|
| Aluminium bracket | 846 554-00 |

A separate aluminium bracket can be used to attach a single tube to any bench.



# Light and balancer rail

Apart from the Treston Wave LED ESD and Naturlite LED Wing 500 all luminaires are fitted to light/balancer rails which are height and depth adjustable. Tool balancer rails and sliding pieces facilitate the use of heavy equipment. A tool balancer is fixed to the light/balancer rail.

### Light and balancer rail (includes one sliding piece)

| Modular size  | Width of the front profile mm | Max load kg | Code ESD    |
|---------------|-------------------------------|-------------|-------------|
| 2 x M500      | 1000                          | 15          | 918 49 001P |
| 2 x M500/1500 | 1500                          | 15          | 918 49 002P |
| 4 x M500      | 2000                          | 15          | 918 49 003P |
| M750          | 750                           | 15          | 918 49 004P |
| M750/900      | 900                           | 15          | 918 49 013P |
| M750/1500     | 1500                          | 15          | 918 49 005P |
| 2 x M750      | 1500                          | 15          | 918 49 006P |
| 3 x M750      | 2250                          | 15          | 918 49 012P |
| M900          | 900                           | 15          | 918 49 007P |
| 2 x M900      | 1800                          | 15          | 918 49 008P |
| M900/1500     | 1500                          | 15          | 918 49 009P |
| M1200         | 1200                          | 15          | 918 49 010P |
| M1350         | 1350                          | 15          | 918 49 011P |

With extension benches you also need a center bracket, code 860 074-49



+

Lighting solutions from page 53.

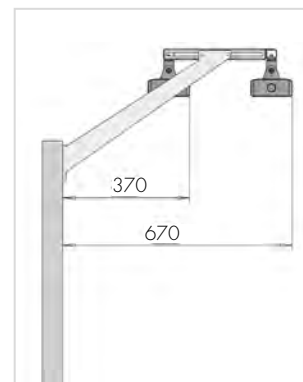
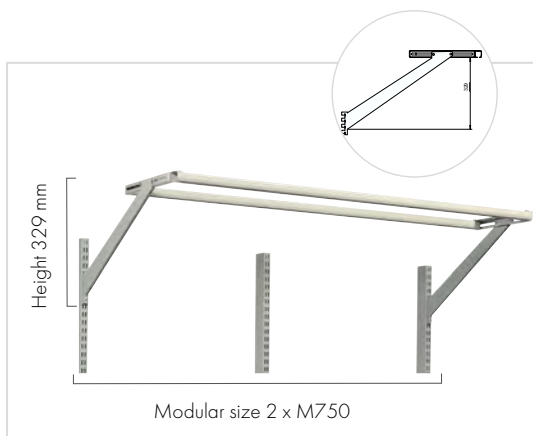
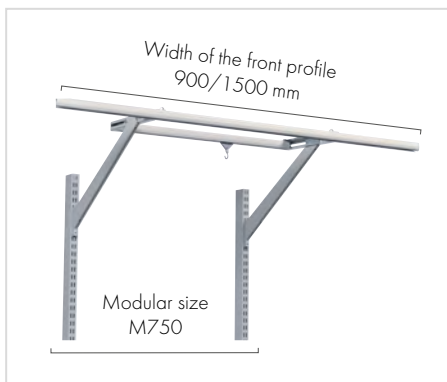

### Tool balancers and other supplies

| Name                           | Tool weight kg | Code ESD   |
|--------------------------------|----------------|------------|
| Tool balancer 2DU              | 0,5 - 1        | 939 502-00 |
| Tool balancer 4DU              | 1 - 2          | 939 503-00 |
| Sliding piece with a snap hook |                | 890 557-51 |



Tool balancer

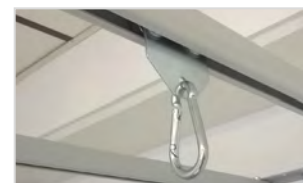

Sliding piece with a snap hook

# Shelves

## Tiltable top shelf TTS

| Module | Size W x D mm | Max load kg | Code         |
|--------|---------------|-------------|--------------|
| M500   | 467 x 300     | 80          | TTSM5003-49  |
| M500   | 467 x 400     | 80          | TTSM5004-49  |
| M750   | 717 x 300     | 80          | TTSM7503-49  |
| M750   | 717 x 400     | 80          | TTSM7504-49  |
| M900   | 870 x 300     | 80          | TTSM9003-49  |
| M900   | 870 x 400     | 80          | TTSM9004-49  |
| M1000  | 967 x 300     | 80          | TTSM10003-49 |
| M1000  | 967 x 400     | 80          | TTSM10004-49 |
| M1200  | 1167 x 300    | 80          | TTSM12003-49 |
| M1200  | 1167 x 400    | 80          | TTSM12004-49 |
| M1350  | 1320 x 300    | 80          | TTSM13503-49 |
| M1350  | 1320 x 400    | 80          | TTSM13504-49 |
| M1500  | 1467 x 300    | 80          | TTSM15003-49 |
| M1500  | 1467 x 400    | 80          | TTSM15004-49 |
| M1800  | 1773 x 300    | 80          | TTSM18003-49 |
| M1800  | 1773 x 400    | 80          | TTSM18004-49 |
| M2000  | 1973 x 300    | 80          | TTSM20003-49 |
| M2000  | 1973 x 400    | 80          | TTSM20004-49 |

Max. tilt 20 degrees (depth 300 mm) or 12,5 degrees (depth 400 mm). Front lip height 30 mm. Can also be installed at the back of the shelf.



Tiltable top shelf M500, M750, M900, M1000, M1200, M1350, M1500, M1800, M2000

## Accessory box for under TTS-shelf

| Suitable for                        | Size D x H mm | Code      |
|-------------------------------------|---------------|-----------|
| Tiltable top shelf TTS depth 300 mm | 220 x 300     | ABTTS3-49 |
| Tiltable top shelf TTS depth 400 mm | 220 x 370     | ABTTS4-49 |

Includes a black ESD (-49) 3020 or 4020 bin.



Accessory box for under TTS-shelf

## Steel shelf

| Module | Size W x D mm | Max load kg | Code       |
|--------|---------------|-------------|------------|
| M500   | 490 x 300     | 50          | 860 804-49 |
| M500   | 490 x 400     | 50          | 860 805-49 |
| M750   | 740 x 300     | 50          | 836 028-49 |
| M750   | 740 x 400     | 50          | 852 770-49 |
| M900   | 890 x 300     | 50          | 852 283-49 |
| M900   | 890 x 400     | 50          | 852 769-49 |
| M1000  | 990 x 300     | 50          | 890 631-49 |
| M1000  | 990 x 400     | 50          | 890 632-49 |
| M1350  | 1340 x 300    | 50          | 860 787-49 |
| M1350  | 1340 x 400    | 50          | 860 788-49 |
| M1500  | 1490 x 300    | 50          | 890 756-49 |
| M1500  | 1490 x 400    | 50          | 890 757-49 |



Steel shelf M500, M750, M900, M1000, M1350, M1500



Due to the dual-purpose shelf brackets, the steel shelf can be used either as tilted 20° or in a horizontal position. The shelf has an integrated edge, which can be used either in the front or back of the shelf, depending on the use of the shelf.

**Divider hoops set (4 pcs)**

| Suitable for                        | Size D x H mm | Code      |
|-------------------------------------|---------------|-----------|
| Tiltable top shelf TTS depth 300 mm | 300 x 400     | PDH300-49 |
| Tiltable top shelf TTS depth 400 mm | 400 x 400     | PDH400-49 |

**Divider pair**

| Suitable for                        | Size D x H mm | Code       |
|-------------------------------------|---------------|------------|
| Steel shelf depth 300 mm            | 285 x 190     | 010 004-49 |
| Steel shelf depth 400 mm            | 385 x 190     | 010 005-49 |
| Tiltable top shelf TTS depth 300 mm | 285 x 190     | 861 116-49 |
| Tiltable top shelf TTS depth 400 mm | 385 x 190     | 861 118-49 |

**Adjustable shelf**

| Module | Size W x D mm | Max load kg | Code        |
|--------|---------------|-------------|-------------|
| M500   | 470 x 505     | 100         | 920 49 001P |
| M500   | 470 x 650     | 100         | 920 49 002P |
| M750   | 720 x 505     | 100         | 920 49 005P |
| M750   | 720 x 650     | 100         | 920 49 006P |
| M900   | 870 x 505     | 100         | 920 49 009P |
| M900   | 870 x 650     | 100         | 920 49 010P |
| M1350  | 1320 x 505    | 100         | 920 49 013P |
| M1350  | 1320 x 650    | 100         | 920 49 014P |

**Adjustable shelf, stepless depth adjustment**

| Module | Size W x D mm | Max load kg | Code        |
|--------|---------------|-------------|-------------|
| M500   | 470 x 505     | 50          | 920 49 003P |
| M500   | 470 x 650     | 50          | 920 49 004P |
| M750   | 720 x 505     | 50          | 920 49 007P |
| M750   | 720 x 650     | 50          | 920 49 008P |
| M900   | 870 x 505     | 50          | 920 49 011P |
| M900   | 870 x 650     | 50          | 920 49 012P |

**+** Additional adjustable shelves on page 63.

**Pull-out steel shelf**

| Module | Size W x D mm | Max load kg | Code        |
|--------|---------------|-------------|-------------|
| M750   | 720 x 390     | 30          | 925 49 002P |
| M900   | 870 x 390     | 30          | 925 49 003P |

**Document shelf**

| Module | Size W x D mm | Max load kg | Code       |
|--------|---------------|-------------|------------|
| M500   | 470 x 265     | 5           | 860 806-49 |
| M750   | 720 x 265     | 5           | 860 115-49 |
| M900   | 870 x 265     | 5           | 860 399-49 |

**Flow-through shelf**

| Module | Size W x D mm | Max load kg | Code       |
|--------|---------------|-------------|------------|
| M750   | 718 x 830     | 150         | 890 710-49 |

A flow-through shelf can fit two 400 mm deep bins in depth direction.



Divider hoops set



Divider pair

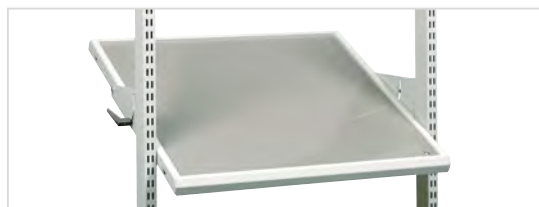

Adjustable shelf, tilting 0-25°



Steplessly adjustable shelf, tilting 0-25°



Pull-out steel shelf



Document shelf, tilting 10 - 75°

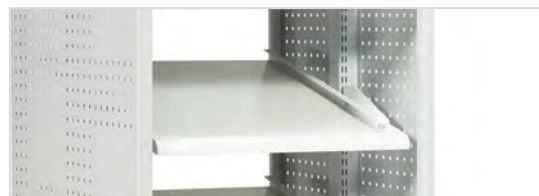

Flow-through shelf



# Upright accessories

## Adjustable auxiliary shelf

| Name                       | Size<br>W x D mm | Tilting | Max<br>load kg | Code ESD    |
|----------------------------|------------------|---------|----------------|-------------|
| Adjustable auxiliary shelf | 560 x 340        | 0-25°   | 15             | 927 49 001P |
| Adjustable auxiliary shelf | 605 x 405        | 0-25°   | 15             | 927 49 002P |



Adjustable auxiliary shelf

## IT shelves and trays

| Name                                       | Size<br>W x D x H mm                              | Max<br>load kg | Code ESD    |
|--|---|----------------|-------------|
| Laptop / printer shelf                     | 365 x 365   | 25             | 930 49 001P |
| Keyboard tray for laptop shelf             | 480 x 270   | 5              | 860 904-49  |
| Keyboard and mouse tray for laptop shelf   | 620 x 270   | 5              | 860 903-49  |
| Keyboard tray (attached to the bench top)* | 680 x 375 x 106 (outer)<br>620 x 305 x 90 (inner) | 10             | 925 49 001P |



Laptop/printer shelf with arm



Keyboard tray (attached to the bench top)

\*Suitable also for WB, TP and TPH benches.

## Holder for Thin Client PC

| Name                      | Size W x D x H mm | Max load kg | Code ESD |
|---------------------------|-------------------|-------------|----------|
| Holder for Thin Client PC | 250 x 45-65 x 145 | 5           | TCH      |

Fixed to keyboard tray 860941-49 or 860942-49.



Holder for Thin Client PC

## LCD monitor holder for perforated panel

| Name                                    | Max load kg | Code ESD   |
|---|-------------|------------|
| LCD monitor holder for perforated panel | 10          | 890 715-49 |

Suitable for VESA 75/100



LCD monitor holder for perforated panel

## Display bracket for light duty for TED desk

| Name  | Suitable for | Max load kg | Code ESD |
|---|--------------|-------------|----------|
| Display bracket for light duty for TED desk | TED          | 7           | TDB-49   |

Suitable for VESA 75/100



Display bracket for light duty

## LCD holder with double arm

| Name                                   | Size W x D x H mm | Max load kg | Code ESD    |
|--|-------------------|-------------|-------------|
| LCD holder with double arm*            |                   | 15          | 930 49 002P |
| Keyboard tray for LCD holder           | 480 x 260         | 5           | 860 941-49  |
| Keyboard and mouse tray for LCD holder | 620 x 260         | 5           | 860 942-49  |

Fixed to keyboard tray 860941-49 or 860942-49.



LCD holder with double arm

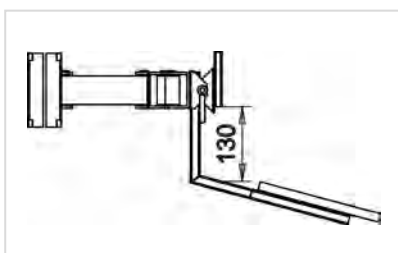

Maximum distance between the LCD holder and keyboard tray



LCD-holder & keyboard tray

**Equipment tray**

| Name             | Size W x D mm   | Max load kg | Code ESD    |
|------------------|-----------------|-------------|-------------|
| Equipment tray   | 250 x 250 x 90  | 10          | 928 49 001P |
| Equipment tray   | 500 x 250 x 125 | 15          | 928 49 002P |
| Equipment tray * | 500 x 250 x 125 | 30          | 928 49 003P |

\*Comes with heavy arm.



Equipment tray

**Bin shelf**

| Name                     | Size W x D mm   | Max load kg | Code ESD    |
|--------------------------|-----------------|-------------|-------------|
| Bin shelf                | 560 x 175 x 125 | 15          | 928 49 005P |
| Bin shelf                | 600 x 220 x 125 | 15          | 928 49 006P |
| Stand for picking bins** | 560 x 165 x 355 |             | 860 113-49  |

\*\*Space for 15 picking bins 30-1L-4ESD



Bin shelf



Stand for stacking bins

**Document holders**

| Name               | Size W x D mm | Max load kg | Code ESD    |
|--------------------|---------------|-------------|-------------|
| Document holder A4 | 290 x 330     | 5           | 928 49 008P |
| Document holder A3 | 418 x 330     | 5           | 928 49 009P |



Document holder

**Tool panel**

| Name       | Size W x D mm | Max load kg | Code ESD    |
|------------|---------------|-------------|-------------|
| Tool panel | 267 x 305     | 5           | 928 49 010P |



Tool panel

**Bin rails with arms**

| Name                                   | Size W x D mm | Max load kg | Code ESD    |
|--|---------------|-------------|-------------|
| Curved bin rail with arm               | 770 x 54      | 15          | 929 49 002P |
| Extension for curved bin rail with arm | 770 x 54      |             | 860 911-49  |



Curved bin rail with arm



Extension for curved bin rail with arm

**Rotating tool frame**

| Name   | Size W x D mm | Max load kg | Code ESD    |
|--|---------------|-------------|-------------|
| Rotating tool panel frame, height-adjustable arm | 513 x 320     | 15          | 860 864-49P |
| Rotating tool panel frame, double arm            | 513 x 320     | 15          | 880 865-49P |

The rotating tool panel frame can be equipped with perforated panels and tool troughs. The rotating tool frame is compatible with all M500 accessories, such as the tool trough and the bin rails.



**Rotating tool panel frame with double arm**

**Accessories for rotating tool frame**

| Name  | Size W x D mm  | Max load kg | Code ESD   |
|---|----------------|-------------|------------|
| Perforated panel                                | 470 x 300      |             | 860 951-49 |
| Tool trough M500                                | 470 x 150      |             | 860 952-49 |
| Bin rail M500                                   | 492 x 90       | 15*         | 859 150-49 |
| Light bin rail M500                             | 492 x 54       | 10          | 860 953-49 |
| Aluminium bin rail M500 for rotating tool panel | 486 x 55 x 75  | 15          | BP500C     |
| Auxiliary steel shelf                           | 217 x 298 x 20 | 3           | ASSA4      |
| Auxiliary steel shelf                           | 159 x 254 x 50 | 2           | ASSA5      |

\*Actual bin rail max load 40 kg but with arm 15 kg.



**Rotating tool panel frame with M500 perforated panel, M500 bin rails and 8 plastic ESD bins**

**Replacement arms (spare parts)**

| Name  | Length mm     | Max load kg | Code ESD   |
|---|---------------|-------------|------------|
| Double arm, 40 mm   | 200+200       | 10          | 880 020-49 |
| Double arm, 60 mm   | 200+200       | 15          | 880 010-49 |
| Heavy arm, 60 mm  | 287+221       | 30          | 860 993-49 |
| Height-adjustable arm with gas spring, 60 mm (height adjustment range 165 mm) | 375           | 15          | 860 985-49 |
| Height-adjustable profile   | 55 x 80 x 590 | 15          | 860 997-49 |

LCD screen holder for 60 mm double, heavy or height adjustable arms: 860940-49.



**Double arm**



**Heavy arm**



**Height-adjustable arm**



**Height-adjustable profile**

**When a position changes, the height must be adjusted**

Frequent changes in the working position, such as changing from a sitting position to a standing position, require height-adjustable arm (860 985-49). The height-adjustable profile (860 997-49) can be attached to any rack with arm (such as the PC rack) that is pulled down and lifted back up according to the working position. The adjustment range is 450 mm.

**Arm adapters for Concept, QuatreX, TED, Quick Edge and TP accessories with arms**

| Profile type            | Workbench / trolley model | 40 mm arm   | 60 mm arm   |
|-------------------------|---------------------------|-------------|-------------|
| C-profiles              | TPH                       | -           | E824 081-49 |
| AL2X aluminium profiles | WB, QuatreX               | 890 524-49  | 890 525-49  |
| Aluminium profiles      | WTR                       | E821 573-49 | E821 572-49 |

Arm accessories for upright tubes can be used in other profile types with adapters.



**Auxiliary top, fixed brackets**

| Name                | Size W x D mm | Max load kg | Code ESD    |
|---------------------|---------------|-------------|-------------|
| Auxiliary top left  | 400 x 500     | 40          | 926 49 001P |
| Auxiliary top right | 400 x 500     | 40          | 926 49 002P |



Auxiliary top

**Bottle holder**

| Name                                   | Code ESD   |
|--|------------|
| Bottle holder (Ø 100) for upright tube | 859 063-49 |



Bottle holder

**Roll holder for upright tube**

| Name  | Code ESD   |
|---|------------|
| Roll holder for upright tube (roll ø height 150 mm, width 320 mm) | 860 841-49 |



Roll holder

# Cable management

**Cable ducts**

| Name       | Size W x H mm | Suitable for module | Code ESD   |
|------------|---------------|---------------------|------------|
| Cable duct | 467 x 360     | M500                | 860 808-49 |
| Cable duct | 717 x 360     | M750                | 860 044-49 |
| Cable duct | 870 x 360     | M900                | 860 045-49 |

Suitable only for Concept bench. Fitted to upright tube.

Cable ducts hide the untidy cables from other equipment. This makes it easy to keep the back of the workstation and its surroundings tidy.

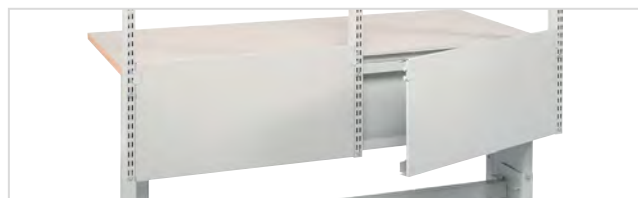

Hide wires and cables with a cable duct.

**Horizontal cable troughs**

| Name                    | Size W x D x H mm | Suitable for module | Code ESD   |
|-------------------------|-------------------|---------------------|------------|
| Horizontal cable trough | 737 x 97 x 45     | M750                | 854 553-49 |
| Horizontal cable trough | 890 x 97 x 45     | M900                | 854 554-49 |
| Horizontal cable trough | 1187 x 97 x 45    | M1200               | 854 555-49 |
| Horizontal cable trough | 1337 x 97 x 45    | M1350               | 890 551-49 |
| Horizontal cable trough | 1487 x 97 x 45    | M1500               | 854 556-49 |
| Horizontal cable trough | 1793 x 97 x 45    | M1800               | 854 557-49 |

Horizontal troughs effectively conceal the cables, without preventing maintenance access.

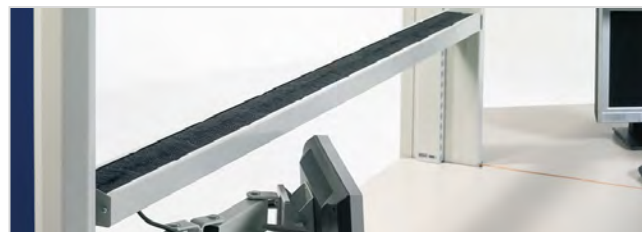

Fitted to upright tubes, the horizontal cable trough enables cables to be hidden at the top of the workstation.

**Vertical cable trough**

| Name                  | Size W x D x H mm | Code ESD   |
|-----------------------|-------------------|------------|
| Vertical cable trough | 52 x 62 x 1360    | 861 130-49 |

The vertical cable trough is fitted on the side of the upright tube.

Vertical cable trough



**Treston Cable Tidy**

| Name               | Size W x D x H mm | Suitability | Code ESD |
|--------------------|-------------------|-------------|----------|
| Treston Cable Tidy | 800 x 62 x 100    | TED         | TCT-49   |

Treston cable tidy hides the cables below the worktop.



Treston Cable Tidy for TED

# CPU cabinets and holders

## 1. CPU/printer holder, bar clamp

| Size<br>W x D x H mm | Max<br>load kg | Suitable for               | Code ESD   |
|----------------------|----------------|----------------------------|------------|
| >150 x 500 x 85      | 20             | Concept with accessory bar | 860 551-49 |



## 2. CPU holder

| Size<br>W x D x H mm | Max<br>load kg | Suitable for                     | Code ESD   |
|----------------------|----------------|----------------------------------|------------|
| 180-225 x 450 x 50   | 20             | Concept allen key and hand crank | 860 552-49 |



## 3. CPU holder

| Size<br>W x D x H mm | Max<br>load kg | Suitable for                | Code ESD   |
|----------------------|----------------|-----------------------------|------------|
| 180-225 x 450 x 50   | 20             | Concept electric adjustable | 860 740-49 |



## 5. CPU holder

| Size<br>W x D x H mm | Max<br>load kg | Suitable for   | Code ESD   |
|----------------------|----------------|----------------|------------|
| 180-225 x 450 x 50   | 20             | TP/TPH benches | 854 440-49 |



# Footrests

## Footrest, floor

| Size W x D mm | Height | Tilting | Suitable for | Code ESD   |
|---------------|--------|---------|--------------|------------|
| 550 x 350     | 100    | 5-30    | All benches  | 860 947-49 |



Footrest, floor

## Footrest, floor, height adjustable

| Size W x D mm | Height | Tilting | Suitable for | Code ESD   |
|---------------|--------|---------|--------------|------------|
| 550 x 350     | 90-280 | 5-30    | All benches  | 860 137-49 |



Footrest, floor, height adjustable

## Footrest, floor, with gas action

| Size W x D mm | Height | Tilting | Suitable for | Code ESD   |
|---------------|--------|---------|--------------|------------|
| 550 x 350     | 90-260 | 5-30    | All benches  | 860 224-49 |

## Footrest, bar

| Size W x D mm | Height | Tilting | Suitable for | Code ESD   |
|---------------|--------|---------|--------------|------------|
| 550 x 350     | 90-280 | 5-30    | Concept      | 860 136-49 |

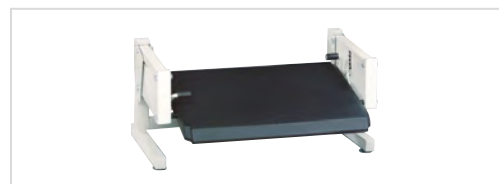

Footrest, floor, with gas action

## Footrest, bar, with gas action

| Size W x D mm | Height | Tilting | Suitable for | Code ESD   |
|---------------|--------|---------|--------------|------------|
| 550 x 350     | 90-260 | 5-30    | Concept      | 860 196-49 |

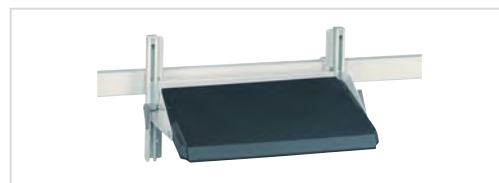

Footrest, bar

## Accessory bars

| Name                  | Bench frame width mm | Depth adjustment mm | Code ESD   |
|-----------------------|----------------------|---------------------|------------|
| Accessory bar Concept | 1000                 | -                   | 860 084-49 |
| Accessory bar Concept | 1200                 | -                   | 860 085-49 |
| Accessory bar Concept | 1500                 | 150                 | 860 088-49 |
| Accessory bar Concept | 1500                 | -                   | 860 086-49 |
| Accessory bar Concept | 1800                 | 150                 | 860 089-49 |
| Accessory bar Concept | 1800                 | -                   | 860 083-49 |
| Accessory bar Concept | 2000                 | 150                 | 860 090-49 |

The accessory bar can be used to fix a footrest or a CPU/printer holder. The accessory bar is included with the hand crank and motor adjustable Concept benches.



Footrest, bar, with gas action

# Stacking bins and shelf bins

Another way of ensuring an ergonomic working position and saving space is to use bin rails. The higher the rails are, the further they are from the workstation. To ensure an ergonomic working position, use the extension bracket pair on the higher rails. The bin rails are available in six standard module sizes.



Bin rail with stacking bins.



Light bin rail with stacking bins.



Aluminium bin rail BP and ASSA4

| Name                     | Suitable for module | Size W x D mm  | Max load kg | Code ESD   |
|--------------------------|---------------------|----------------|-------------|------------|
| Bin rail                 | M500                | 492 x 100      | 50          | 859 150-49 |
| Light bin rail           | M500                | 492 x 54       | 10          | 860 953-49 |
| Bin rail                 | M750                | 742 x 100      | 50          | 859 151-49 |
| Light bin rail           | M750                | 742 x 54       | 10          | 860 955-49 |
| Bin rail                 | M900                | 895 x 100      | 50          | 859 152-49 |
| Light bin rail           | M900                | 895 x 54       | 10          | 860 956-49 |
| Bin rail                 | M1000               | 967 x 100      | 50          | 859 156-49 |
| Bin rail                 | M1200               | 1167 x 100     | 50          | 859 157-49 |
| Bin rail                 | M1350               | 1343 x 100     | 50          | 859 153-49 |
| Bin rail                 | M1500               | 1493 x 100     | 50          | 859 154-49 |
| Bin rail                 | M1800               | 1799 x 100     | 50          | 859 155-49 |
| Extension bracket pair   |                     | 60             | 50          | 860 919-49 |
| Aluminium bin rail M500  |                     | 486 x 55 x 75  | 40          | BP500C     |
| Aluminium bin rail M750  |                     | 736 x 55 x 75  | 40          | BP750C     |
| Aluminium bin rail M900  |                     | 889 x 55 x 75  | 40          | BP900C     |
| Aluminium bin rail M1350 |                     | 1320 x 55 x 75 | 40          | BP1350C    |
| Aluminium bin rail M1500 |                     | 1486 x 55 x 75 | 40          | BP1500C    |
| Aluminium bin rail M1800 |                     | 1792 x 55 x 75 | 40          | BP1800C    |
| Auxiliary steel shelf    |                     | 217 x 330 x 50 | 3           | ASSA4      |
| Auxiliary steel shelf    |                     | 159 x 254 x 50 | 2           | ASSA5      |

Light bin rail is recommended only for the small stacking bins.



## Stacking bins

| No. | Capacity l | Outer dims W x D x H mm | Inner dims W x D x H mm                     | Pack pcs | Code ESD*    |
|-----|------------|-------------------------|---|----------|--------------|
| 1.  | 0,6        | 105 x 165 x 75          | 90 x 105 x 65                               | 60       | 1015-4 ESD   |
| 2.  | 2,7        | 149 x 250 x 130         | 125 x 185 x 115                             | 30       | 1525-4 ESD   |
| 3.  | 5,0        | 186 x 300 x 156         | 155 x 230 x 140                             | 24       | 1930-4 ESD   |
| 4.  | 7,2        | 186 x 400 x 156         | 155 x 330 x 140                             | 24       | 1940-4 ESD   |
| 5.  | 1,1        | 99 x 160 x 70           | 85 x 100 x 62                               | 60       | 30-1L-4 ESD  |
| 6.  | 2,2        | 198 x 160 x 70          | 175 x 100 x 62                              | 30       | 30-2L-4 ESD  |
| 7.  | 2,2        | 198 x 160 x 70          | 175 x 100 x 62<br>(2 fixed length dividers) | 30       | 30-23L-4 ESD |

## Labels and cross dividers

| Labels + shields | Pack min. order | Cross divider | Pack pcs |
|------------------|-----------------|---------------|----------|
| E-10             | 60              |               |          |
| E-15             | 30              | V-14          | 30       |
| E-20             | 24              | V-19          | 24       |
| E-20             | 24              | V-19          | 24       |

\*) Order number/one item.

## Fixing stacking bins on the bin rail

| Bin rail       | M500 | M750 | M900 | M1350 | M1500 | M1800 | Curved bin rail |
|----------------|------|------|------|-------|-------|-------|-----------------|
| 1015           | 4    | 7    | 8    | 12    | 14    | 17    |                 |
| 1525           | 3    | 5    | 6    | 9     | 10    | 12    |                 |
| 1930 & 1940    | 2    | 4    | 4    | 7     | 8     | 9     |                 |
| 30-1L          | 5    | 7    | 9    | 13    | 15    | 17    | 5               |
| 30-2L & 30-23L | 2    | 3    | 4    | 7     | 7     | 9     |                 |



**Shelf bins**

| No. | Capacity l | Outer dims W x D x H mm | Inner dims W x D x H mm | Pack pcs | Code ESD*  | Cross dividers |    |
|-----|------------|-------------------------|-------------------------|----------|------------|----------------|----|
| 1.  | 1,9        | 92 x 400 x 82           | 75 x 357 x 70           | 30       | 4010-4 ESD | D-10-4ESD      | 6  |
| 2.  | 2,4        | 92 x 500 x 82           | 75 x 457 x 70           | 30       | 5010-4 ESD | D-10-4ESD      | 8  |
| 3.  | 4,2        | 186 x 400 x 82          | 167 x 357 x 70          | 15       | 4020-4 ESD | D-20-4ESD      | 6  |
| 4.  | 5,3        | 186 x 500 x 82          | 167 x 457 x 70          | 15       | 5020-4 ESD | D-20-4ESD      | 8  |
| 5.  | 6,5        | 186 x 600 x 82          | 167 x 557 x 70          | 15       | 6020-4 ESD | D-20-4ESD      | 10 |

\*) Order number/one item.

**Cross dividers**

Please see our wide bin selection in our Main catalogue.

[treston.com/catalogues-and-brochures](http://treston.com/catalogues-and-brochures)

# Perforated panels

**Perforated panels for upright tubes**

| Name                             | Module | Size W x H mm | Code ESD   |
|----------------------------------|--------|---------------|------------|
| Perforated back panel            | M500   | 468 x 389     | 861 501-49 |
| Perforated back panel            | M750   | 718 x 389     | 861 511-49 |
| Perforated back panel            | M750   | 718 x 612     | 861 512-49 |
| Perforated back panel, insulated | M750   | 718 x 612     | 861 701-49 |
| Perforated back panel            | M750   | 718 x 1003    | 861 514-49 |
| Perforated back panel            | M900   | 871 x 389     | 861 516-49 |
| Perforated back panel            | M900   | 871 x 612     | 861 517-49 |
| Perforated back panel            | M900   | 871 x 1003    | 861 519-49 |
| Perforated back panel            | M1000  | 968 x 389     | 861 532-49 |
| Perforated back panel            | M1000  | 968 x 612     | 861 538-49 |
| Perforated back panel            | M1200  | 1168 x 389    | 861 533-49 |
| Perforated back panel            | M1350  | 1318 x 389    | 861 521-49 |
| Perforated back panel            | M1500  | 1474 x 389    | 861 526-49 |
| Perforated back panel            | M1800  | 1774 x 389    | 861 531-49 |

Fastened to the upright tubes (see page 29).



**Auxiliary steel shelf for perforated panel**

| Size W x D x H mm | Suitable for     | Code ESD |
|-------------------|------------------|----------|
| 159 x 243 x 56    | Perforated panel | ASSA5PP  |

Auxiliary steel shelf for A5 documents, tape dispenser or handheld scanner. Attached to the perforated panel.

**Auxiliary steel shelf for perforated panel**

# ESD accessories for WB and QuatreX

## Upright profiles for WB

| Size W x H mm | Suitable for | Code ESD  |
|---------------|--------------|-----------|
| 1063 x 900    | WB811        | AL2X110 W |
| 1489 x 900    | WB815        | AL2X150 W |
| 1789 x 900    | WB818        | AL2X180 W |

Needed for mounting accessories to WB benches. Includes 2 vertical and 1 horizontal profile. With 3 cable clips (CC8). Load capacity 100 kg/AL2X.

## Upright profiles for Treston QuatreX

| Size W x H mm | Suitable for bench widths | Code ESD  |
|---------------|---------------------------|-----------|
| 1060 x 1200   | 1025*, 1225               | AL2X110QX |
| 1489 x 1200   | 1525                      | AL2X150QX |
| 1789 x 1200   | 1825, 2025                | AL2X180QX |

Needed for mounting aluminium accessories to the Treston QuatreX bench. Includes 2 vertical and 1 horizontal profile. With 3 cable clips (CC8). Load capacity 150 kg/AL2X.

\*without horizontal profile

## Accessory frame AKK

| Size W x D mm         | Suitable for                                 | Code ESD |
|-----------------------|--|----------|
| 730 x 540             | AL2X110 W/QX<br>AL2X150 W/QX<br>AL2X180 W/QX | AKK70    |
| 690 x 500 + 690 x 500 | AL2X150 W/QX                                 | AKK150   |
| 690 x 500 + 990 x 500 | AL2X180 W/QX                                 | AKK180   |

Divides the space between the upright profiles into 2 modules. AKK frame includes 1 vertical and 1 horizontal profile. Useable height 500 mm.

## Support bracket HSB

| Length mm | Suitable for | Code ESD |
|-----------|--------------|----------|
| 1073      | AL2X110 W/QX | HSB110   |
| 1500      | AL2X150 W/QX | HSB150   |
| 1800      | AL2X180 W/QX | HSB180   |

Support bracket of steel for suspending power tools and lighting units. Mount on upright profiles.

## Cable tidy WBCT

| Size W x D x H mm | Suitable for | Code ESD |
|-------------------|--------------|----------|
| 948 x 64 x 204    | WB811        | WBCT110  |
| 1375 x 64 x 204   | WB815        | WBCT150  |
| 1675 x 64 x 204   | WB818        | WBCT180  |

Mount on leg frame. We recommend using the cable tidy WBCT with WB Allen-key adjustable benches. The cable tidy is standard equipment on WB C and WB EL models.

## Shelf ALH

| Size W x D mm | Suitable for                                       | Code ESD   |
|---------------|--|------------|
| 1073 x 310    | AL2X110 W/QX, combination<br>AL2X180 W/QX + AKK180 | ALH110 ESD |
| 1500 x 310    | AL2X150 W/QX                                       | ALH150 ESD |
| 1800 x 310    | AL2X180 W/QX                                       | ALH180 ESD |

Height adjustable shelf. 25 mm laminated particle board. Load capacity 50 kg. Mount on upright profiles.

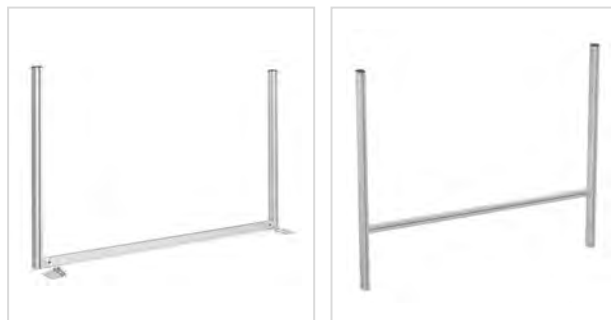

Upright profiles AL2X / AL2XQX



Accessory frame AKK



Support bracket HSB



Cable tidy WBCT



Shelf ALH

**Lower shelf AT**

| Size<br>W x D mm | Max<br>load kg | Suitable for | Code ESD     |
|------------------|----------------|--------------|--------------|
| 828 x 400        | 50             | WB811        | AT110 WB ESD |
| 1255 x 400       | 50             | WB815        | AT150 WB ESD |
| 1555 x 400       | 50             | WB818        | AT180 WB ESD |

Height adjustable lower shelf, 25 mm laminated particle board. Mount between the legs.

**Divider hoops PDH**

| Height mm | Suitable for | Code ESD |
|-----------|--------------|----------|
| 400       | ALH          | PDH      |

Used in combination with shelf ALH. Comes in sets of 5.

**Backstop LIST**

| Size W x D x H mm | Suitable for                | Code ESD |
|-------------------|-----------------------------|----------|
| 1400 x 52 x 27    | ALH 150 ESD, AT150 WB ESD   | LIST150  |
| 1700 x 52 x 27    | ALH180 WB ESD, AT180 WB ESD | LIST180  |

Prevents items from falling off the shelf. Can be fixed on the lower shelf AT or on the shelf ALH.

**Adjustable shelf ASH**

| Size W x D mm | Suitable for          | Code ESD   |
|---------------|-----------------------|------------|
| 660 x 400     | AKK70, AKK150, AKK180 | ASH70 ESD  |
| 960 x 400     | AKK180, AL2X110W/QX   | ASH100 ESD |

Continuous adjustment for depth, height and angle. Shelf of 25 mm laminated particle board. Lipped front edge. Load capacity 35 kg static load. Mount on accessory frame AKK.

**Swivel arm with tray AKV**

| Size W x D mm    | Suitable for          | Code ESD   |
|------------------|-----------------------|------------|
| 460 x 210 (tray) | AL2X upright profiles | AKV400 ESD |

Lockable, angle adjustable steel tray with swivel radius of 360°. Length of swivel arm 590 mm. Max. load 15 kg.

**Keyboard shelf WKA**

| Size W x D mm     | Suitable for          | Code ESD |
|-------------------|-----------------------|----------|
| 500 x 220 (shelf) | AL2X upright profiles | WKA ESD  |

Keyboard shelf with swivel arm. Epoxy powder coated steel. Load capacity 15 kg. Arm length 220 mm.

**Component rack EPL**

| Size<br>W x D x H mm | Suitable<br>for | Shelves<br>number | Code ESD  |
|----------------------|-----------------|-------------------|-----------|
| 455 x 200 x 290      | AKV             | 3                 | EPL12 ESD |

Rack with three fixed shelves. Semiconductive epoxy powder coated steel in light grey (RAL 7035). Bins ordered separately, page 50. Component rack holds: 12 stacking bins 1015-4ESD **or** 12 picking bins 30-1L-4ESD **or** 6 picking bins 30-2L-4ESD **or** 6 picking bins 30-23L-4ESD.



Lower shelf AT



Divider hoops PDH



Backstop LIST



Adjustable shelf ASH



Swivel arm with tray AKV



Keyboard shelf WKA



Component rack EPL



**Bin profile BP**

| Length mm | Suitable for             | Code ESD  |
|-----------|--------------------------|-----------|
| 685       | AKK 70, AKK 150, AKK 180 | BP70 ESD  |
| 985       | AKK 180, AL2X110 W/QX    | BP100 ESD |

Aluminium profile for stacking and picking bins. Mount on accessory frame AKK.



**Bin profile BP**

**Auxiliary steel shelf ASSA**

| Size W x D x H mm | Suitable for | Code ESD |
|-------------------|--------------|----------|
| 217 x 330 x 50    | BP           | ASSA4    |
| 159 x 254 x 50    | BP           | ASSA5    |

Shelf for A4/A5 paper and tape dispensers (max 2 pcs per shelf). Mounted on bin profile. Max load 3 kg.



**Auxiliary steel shelf ASSA4**

**Perforated panel ARL**

| Size W x H mm | Suitable for         | Code ESD |
|---------------|----------------------|----------|
| 668 x 500     | AKK70, AKK150        | ARL70    |
| 968 x 500     | AKK180, AL2X110 W/QX | ARL100   |

Mount on accessory frame AKK. The size of the perforation is 9 x 9 mm, center to center 38 mm.

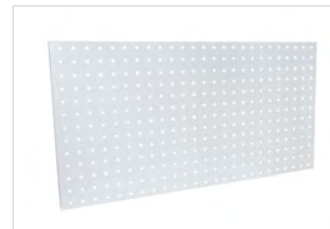

**Perforated panel ARL**



**Auxiliary steel shelf for perforated panel**

**Auxiliary steel shelf for perforated panel**

| Size W x D x H mm | Suitable for         | Code ESD |
|-------------------|----------------------|----------|
| 159 x 243 x 56    | Perforated panel ARL | ASSA5PP  |

Auxiliary steel shelf for A5 documents, tape dispenser or handheld scanner. Attached to the perforated panel.

**Document stand WDA**

| Size W x H mm | Suitable for          | Code ESD |
|---------------|-----------------------|----------|
| 440 x 300     | AL2X upright profiles | WDA ESD  |

Document stand A3 with swivel arm. Epoxy powder coated steel: light grey. Arm length 220 mm. Tilt 75°.



**Document stand WDA**

**Tool tray PTH**

| Size W x D mm | Suitable for                               | Code ESD |
|---------------|--|----------|
| 1000 x 60     | WB, QuatreX, TED, Concept electric benches | PTH100   |

The tool tray guarantees a clean working space, while tools are close to hand.



**Tool tray PTH**

**Arm adapters for Concept, QuatreX, TED, Quick Edge and TP accessories with arms**

| Profile type            | Workbench / trolley model | 40 mm arm   | 60 mm arm   |
|-------------------------|---------------------------|-------------|-------------|
| C-profiles              | TPH                       | -           | E824 081-49 |
| AL2X aluminium profiles | WB, QuatreX               | 890 524-49  | 890 525-49  |
| Aluminium profiles      | WTR                       | E821 573-49 | E821 572-49 |

Arm accessories for upright tubes can be used in other profile types with adapters.



# ESD accessories for TPH

## Tool and lighting support KT

|                 | Size W x D mm | Suitable for | Code ESD |
|-----------------|---------------|--------------|----------|
|                 | 1200 x 600    | TPH712       | KT120    |
|                 | 1500 x 600    | TPH715/915   | KT150    |
|                 | 1800 x 600    | TPH718/918   | KT180    |
| Extra C-profile | 1500          | KT150        | SPR150   |
| Extra C-profile | 1800          | KT180        | SPR180   |

For suspending power tools and lighting units. Includes one C-profile bar with sliding hook.



Tool and lighting support KT

## Upright profiles HKCP

| Height mm | Suitable for | Code ESD |
|-----------|--------------|----------|
| 1470      | TPH          | HKCP147  |

If you mount both perforated panel RL and cable channel TJK to TPH benches, you must order extra-high upright profiles.



Upright profiles HKCP

## Auxiliary shelf SH

| Size W x D mm | Max load kg | Suitable for | Code ESD  |
|---------------|-------------|--------------|-----------|
| 1200 x 310    | 50          | TPH712       | SH120 ESD |
| 1500 x 310    | 50          | TPH715/915   | SH150 ESD |
| 1800 x 310    | 50          | TPH718/918   | SH180 ESD |

Height adjustable shelf. 25 mm laminated particle board.



Auxiliary shelf SH

## Backstop LIST

| Size W x D x H mm | Suitable for | Code ESD |
|-------------------|--------------|----------|
| 1400 x 52 x 27    | SH150 ESD    | LIST150  |
| 1700 x 52 x 27    | SH180 ESD    | LIST180  |

Prevents items from falling off the shelf. Can be fixed on the shelf SH.



Backstop LIST

## Divider hoops PDH

| Height mm | Suitable for | Code ESD |
|-----------|--------------|----------|
| 400       | TPH          | PDH      |

Used in combination with shelf SH. Comes in sets of 5.



Divider hoops PDH

**Lower steel shelf LSS**

| Size W x D mm | Max load kg | Suitable for | Code ESD |
|---------------|-------------|--------------|----------|
| 1418 x 460    | 30          | TPH715/ 915  | LSS150   |
| 1718 x 460    | 30          | TPH718/ 918  | LSS180   |

Hangs on the horizontal bars. Can be equipped with steplessly adjustable low M-divider hoops (4 pcs/set, code LDH).



**Lower steel shelf LSS**

**Metal shelf TH**

| Size W x D mm | Max load kg | Suitable for | Code ESD  |
|---------------|-------------|--------------|-----------|
| 1119 x 145    | 30          | TPH712       | TH120 ESD |
| 1419 x 145    | 30          | TPH715/ 915  | TH150 ESD |
| 1719 x 145    | 30          | TPH718/ 918  | TH180 ESD |

Adjustment for depth, height and angle. For stacking and picking bins. Load capacity 30 kg.



**Metal shelf TH**

**Bin profile BP**

| Width mm     | Max load kg | Suitable for | Code ESD  |
|--------------|-------------|--------------|-----------|
| profile 1115 | 15          | TPH712       | BP120 ESD |
| profile 1415 | 15          | TPH715/ 915  | BP150 ESD |
| profile 1715 | 15          | TPH718/ 918  | BP180 ESD |

Aluminium profile for stacking and picking bins.



**Bin profile BP**

**Auxiliary steel shelf ASSA**

| Size W x D x H mm | Suitable for | Code ESD |
|-------------------|--------------|----------|
| 217 x 330 x 50    | BP           | ASSA4    |
| 159 x 254 x 50    | BP           | ASSA5    |

Shelf for A4/A5 paper and tape dispensers (max 2 pcs per shelf). Mounted on bin profile. Max load 3 kg.



**Auxiliary steel shelf ASSA**

**Perforated panel RL**

| Size W x H mm                          | Suitable for | Code ESD |
|--|--------------|----------|
| 1115 x 750                             | TPH712       | RL120    |
| 1415 x 750                             | TPH715/ 915  | RL150    |
| 1715 x 750                             | TPH718/ 918  | RL180    |
| Connector set for RL perforated panels | TPH          | RK1      |

Robust, perforated steel panel. 9 mm perforations at 38 mm centres. Mount on TPH-benches with connectors RK 1. Can also be attached to a wall with screws (included).



**Perforated panel RL**

**Auxiliary steel shelf for perforated panel**

| Size W x D x H mm | Suitable for        | Code ESD |
|-------------------|---------------------|----------|
| 159 x 243 x 56    | Perforated panel RL | ASSA5PP  |

Auxiliary steel shelf for A5 documents, tape dispenser or handheld scanner. Attached to the perforated panel.



Auxiliary steel shelf for perforated panel

**Cable tidy TPHCT**

| Size W x D x H mm | Suitable for | Code ESD |
|-------------------|--------------|----------|
| 1115 x 45 x 205   | TPH712       | TPHCT120 |
| 1415 x 45 x 205   | TPH715/ 915  | TPHCT150 |
| 1715 x 45 x 205   | TPH718/ 918  | TPHCT180 |

Mounted between C-profiles below worktop. Of perforated epoxy powder coated steel.



Cable tidy TPHCT

**Swivel arm with tray CKV**

| Size W x D mm  | Max load kg | Suitable for | Code ESD   |
|----------------|-------------|--------------|------------|
| Tray 210 x 460 | 15          | TPH          | CKV400 ESD |

Swivel arm with lockable, angle adjustable steel tray. Load 15 kg. Mount on C-profile.



Swivel arm with tray CKV

**Component rack EPL**

| Size W x D x H mm | Suitable for | Shelves number | Code ESD  |
|-------------------|--------------|----------------|-----------|
| 455 x 200 x 290   | CKV          | 3              | EPL12 ESD |

Rack with three fixed shelves. Of semiconductive epoxy powder coated steel in light grey (RAL 7035).



Component rack EPL, swivel arm with tray AKV and bins

**CPU holder**

| Size W x D x H mm  | Max load kg | Suitable for | Code ESD   |
|--------------------|-------------|--------------|------------|
| 180-225 x 450 x 50 | 20          | TP/TPH       | 854 440-49 |



CPU holder

# Other ESD accessories



Earthing box



Earth junction box, yellow



Earthing cable, black



Earthing cable

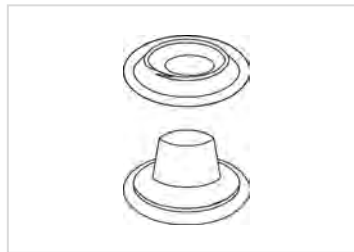

Press stud



Common point ground rail

## Earthing supplies

| Name                                   | Press button        | Resistance | Code ESD   |
|--|---------------------|------------|------------|
| Earthing box                           | 3 x 10 mm           | 1 Mohm     | J6603      |
| Earth junction box, yellow. Cable 2 m. |                     |            | 860 522-00 |
| Earthing cable, black, 1,5 m           | 10 mm / M5 terminal | 1 Mohm     | 860 520-00 |
| Earthing cable 5 m                     | 10 mm               |            | MK3040     |
| Press stud                             | 10 mm / female      |            | PN3034     |
| Common point ground rail               |                     |            | 860 530-00 |

## Wrist straps

| Name                   | Press button | Resistance | Code ESD |
|------------------------|--------------|------------|----------|
| Adjustable wrist strap | 7 mm         | 1 Mohm     | R2216    |
| Metal wrist strap      | 7 mm         | 1 Mohm     | R2206    |

Wrist strap set includes wrist band and coiled cord. Earth lead with 1 megaohm resistor, length 3,6 m. Includes 7 mm press stud for connection to wrist strap and 10 mm press stud for connection to earthing point.



Adjustable wrist strap



Metal wrist strap

## ESD mats

| Name               | Size W x D mm                          | Code ESD   |
|--------------------|--|------------|
| ESD Ergo floor mat | 950 x 650                              | 852 880-00 |
| ESD bench top mat* | 1,22 x 10,00 m (12,20 m <sup>2</sup> ) | PM157      |

\*Resistant to heat, solder flux, most chemicals and solvents. The ESD mats are to EN 61340-5-1 standards. Abraded non slip underside. Does not contain PVC. Supplied by the metre or in rolls. Colour: platinum grey. Resistance surface to ground:  $7,5 \times 10^5 - 10^7$  ohm.



ESD Ergo floor mat



ESD bench top mat



# Non ESD certified accessories



All non ESD certified accessories are EPA –compatible when their combination of the potential charge level and physical distance to the ESDS –related parts is managed by ESD standard IEC 61340-5-1

## Adapter set AS

| Name   | Suitable for  | Code |
|--|---------------|------|
| Adapter set for Concept/QuatreX/TED/TP upright tubes, TPH C-profiles | MH / MA / MA2 | AS2  |
| Adapter for Concept/QuatreX/TED/TP upright tubes                     | MA4           | AS4  |
| Adapter for TPH C-profiles   | MA4           | AS4C |

The above adapter set/adapters are needed for fixing MH/MA/MA2/MA4 to upright tubes and TPH C-profiles. Adapters are not required for WB/QuatreX benches with AL2X uprights.



Adapter set AS2



Adapter AS4



Adapter AS4C

## LCD bracket MH

| Name           | Max load kg | Suitable for                       | Code |
|----------------|-------------|------------------------------------|------|
| LCD bracket MH | 15          | Concept, QuatreX, TED, TP, TPH, WB | MH   |

The quick-release mechanism is equipped with the standard used flat-screen mount 75 x 75 and 100 x 100 for the mounting of all normal flat-screens. **Adapter set AS2 is needed for mounting LCD bracket MH to upright tubes and TPH C-profiles, ordered separately.**



LCD bracket MH

## LCD swivel arm MA

| Name              | Max load kg | Suitable for                       | Code |
|-------------------|-------------|------------------------------------|------|
| LCD swivel arm MA | 10          | Concept, QuatreX, TED, TP, TPH, WB | MA   |

The quick-release mechanism is equipped with the standard flat-screen mount 75 x 75 and 100 x 100 for the mounting of all normal flat-screens. The arm is double articulated, turns through a radius of 180° and will extend between 95-425 mm from the upright. **Adapter set AS2 is needed for mounting LCD swivel arm MA upright tubes and TPH C-profiles, ordered separately.**



LCD swivel arm MA

## LCD swivel arm MA2

| Name               | Max load kg | Suitable for                       | Code |
|--------------------|-------------|------------------------------------|------|
| LCD swivel arm MA2 | 15          | Concept, QuatreX, TED, TP, TPH, WB | MA2  |

The quick-release mechanism is equipped with the standard, widely used flat-screen mount 75 x 75 and 100 x 100 for the mounting of all normal flat-screens. The arm is double articulated, turns through a radius of 180° and will extend between 95-425 mm from the upright. **Adapter set AS2 is needed for mounting LCD swivel arm MA2 upright tubes and TPH C-profiles, ordered separately.**



LCD swivel arm MA2

**LCD screen holder with height adjustable arm MA4**

| Name                  | Max load kg | Suitable for                       | Code |
|-----------------------|-------------|------------------------------------|------|
| LCD screen holder MA4 | 2-7         | Concept, QuatreX, TED, TP, TPH, WB | MA4  |

Highly ergonomic and easily height adjustable monitor arm with a gas spring. Easy mounting of the monitor with a quick-release mechanism, standard flat screen mount 75 x 75 mm and 100 x 100 mm for LCD screens. Cable management by cable clips. The double arm turns through a radius of 180 and will extend between 80-500 mm from the upright. **Adapter AS4/ AS4C is needed for mounting LCD swivel arm MA4 to upright tubes and TPH C-profiles, ordered separately.**



LCD screen holder MA4

**Tablet bracket MY**

| Name              | Suitable for  | Code |
|-------------------|---------------|------|
| Tablet bracket MY | MH, MA or MA2 | MY   |

For 7-10" tablets. Requires either an MH, MA or MA2 swivel arm.



Tablet bracket MY

**PC stand CPU**

| Width      | Height     | Suitable for   | Code |
|------------|------------|--|------|
| 130-240 mm | 395-500 mm | Concept (depth 750/900 mm), QuatreX, TED, WB, TP, TPH benches, | CPU  |
| 340-460 mm | 180-285 mm | SAP, WTR and Concept trolleys                                  |      |

An adjustable holder for either vertical or horizontal CPU, to mount underneath the table worktop.



PC stand CPU

**CC cable clip set for Concept, TP and QuatreX**

| Name                   | Suitable for  | Code |
|------------------------|---------------|------|
| Cable clip set (5 pcs) | Upright tubes | CC5  |

For easy cable management, suitable for up to five cables.



Cable clip set CC5

**Cable clip set for WB and QuatreX**

| Set                    | Suitable for          | Code |
|------------------------|-----------------------|------|
| Cable clip set (5 pcs) | AL2X upright profiles | CC8  |

The cable clip set will hold cables etc. securely and neatly in place along the bench frame. The clips locate in the 8 mm profile slot.



Cable clip set CC8

**Cable clip set for TPH**

| Set                    | Suitable for | Code |
|------------------------|--------------|------|
| Cable clip set (5 pcs) | TPH          | CC12 |

The cable clip set will hold cables etc. securely and neatly in place along the bench frame. The clips locate in the 12 mm profile slot.



Cable clip set CC12

# Treston power rails

New Treston power rails include USB-charging and also fault current protection is available in most of the standard rail lengths available from stock. Stock selection also includes three lengths with 2 x CAT6A data connectors. Also versions with other data and audio connectors and customised combinations of these are available on request.

Power rails come with brackets for fixing to Treston workstations. Rails can be fixed vertically on upright or aluminum profile, horizontally on aluminum profile or on M750 and M900 modules between uprights. With the new bracket set rails can also be fixed straight to the table top or perforated panel. A power rail can be mounted to four different angle on brackets. Length of rail can limit the mounting possibilities.



## Ideal mounting for different lengths

| Code   | Length | Concept, QuatreX and TP uprights | WB and QuatreX aluminum profile | TPH          | TED              |
|--------|--------|----------------------------------|---------------------------------|--------------|------------------|
| TPR3-  | 331    | Vertical                         | Hor/Ver                         | On table top | Upright vertical |
| TPR4-  | 468    | Vertical                         | Hor/Ver                         | On table top | On table top     |
| TPR7-  | 683    | M750 horizontal                  | Hor/Ver                         | On table top | M750             |
| TPR9-  | 836    | M900 horizontal                  | Hor/Ver                         | On table top | M900             |
| TPR14- | 1400   | On table top                     | On table top                    | On table top | On table top     |
| TPR17- | 1700   | On table top                     | On table top                    | On table top | On table top     |

**Power rails**

| Description  | Length | Code      |
|--|--------|-----------|
| 1 3 sockets + 2 x USB                                      | 331    | TPR3-001  |
| 2 6 sockets + switch + 2 x USB                             | 468    | TPR4-001  |
| 3 6 sockets + switch + 2 x USB + 2 x CAT6A                 | 468    | TPR4-003  |
| 4 4 sockets + switch + fault current protection            | 468    | TPR4-004  |
| 5 6 sockets + switch                                       | 468    | TPR4-005  |
| 6 5 sockets + switch + 2 x USB                             | 683    | TPR7-001  |
| 7 5 sockets + switch + 2 x USB + 2 x CAT6A                 | 683    | TPR7-003  |
| 8 4 sockets + switch + fault current protection + 2 x USB  | 683    | TPR7-008  |
| 9 10 sockets + switch                                      | 683    | TPR7-038  |
| 10 6 sockets + switch + 2 x USB                            | 836    | TPR9-001  |
| 11 6 sockets + switch + 2 x USB + 2 x CAT6A                | 836    | TPR9-003  |
| 12 6 sockets + switch + fault current protection + 2 x USB | 836    | TPR9-010  |
| 13 6 sockets + switch + 2 x USB                            | 1400   | TPR14-001 |
| 14 6 sockets + switch + fault current protection + 2 x USB | 1400   | TPR14-010 |
| 13 6 sockets + switch + 2 x USB                            | 1700   | TPR17-001 |
| 14 6 sockets + switch + fault current protection + 2 x USB | 1700   | TPR17-010 |



# Lighting



All lighting units are EPA –compatible when their combination of the potential charge level and physical distance to the ESDS –related parts is managed by ESD standard IEC 61340-5-1

## Treston NaturLite LED



**Treston NaturLite LED Plus 1200**  
Light with tunable colour tone



**Treston NaturLite LED 900**  
Dimmable light for smaller tables



**Treston NaturLite LED 1200**  
Dimmable light for wider tables



**Treston NaturLite LED Wing 500**  
Versatile task light with dimming

| Name  | Control  | Colour temperature | Illuminance ±10% (@1 meter)   | Luminous flux   | Power | Size W x D x H mm                       | Suitability  | Code     |
|---|--|--------------------|---|---|-------|---|--|----------|
| 1. <b>Treston NaturLite LED Plus 1200</b>                 | Controlled via mobile app or separate remote control + ON/OFF button in the luminaire body | 2700 - 6500 K      | @4000 K: 2800 lx (1000 - 2800 lx depending on the colour temperature) | 3200-6300 lm (depending on the selected colour temperature) | 60 W  | 1180 x 120 x 50                         | All Treston and various other industrial workbenches | TNL1200P |
| <b>Remote control for Treston NaturLite LED Plus 1200</b> | Easy to use and save presets via mobile app. White.  |                    |   |   |       | 90 x 90 x 12                            | Treston NaturLite LED Plus 1200                      | TNLPR    |
| 2. <b>Treston NaturLite LED 1200</b>                      | Touch dim button switch for ON/OFF and dimming in the luminaire body                       | 4000 K             | 3100 lx   | 7100 lm   | 56 W  | 1180 x 120 x 50                         | All Treston and various other industrial workbenches | TNL1200  |
| 3. <b>Treston NaturLite LED 900</b>                       | Touch dim button switch for ON/OFF and dimming in the luminaire body                       | 4000 K             | 2300 lx   | 5200 lm   | 42 W  | 900 x 120 x 50                          | All Treston and various other industrial workbenches | TNL900   |
| 4. <b>Treston NaturLite LED Wing 500</b>                  | Touch dim button switch for ON/OFF and dimming in the luminaire body                       | 4000 K             | 800 lx  | 1750 lm   | 14 W  | 430 x 120 x 50 mm (+ bracket 95/120 mm) | Concept, WB, QuatreX, TED, TP, TPH and TPB benches*  | TNL500W  |

**Common features:** Dimmable, Lifetime > 50 000 hours (L90B10), Color Rendering Index CRI > 80, High quality LED (MacAdams < 3) Aluminium body, 2 years guarantee, Enclosure protection IP20

\* TPH and TPB benches require bracket 890 683-49



Watch this [animation](#) and get the main facts of the Treston NaturLite LED lights in less than 2 minutes



# Cutting edge technology

- Tunable colour tone (2700-6500 K)
- Power 14-60 W (max)
- Illuminance 800-3100 lx  $\pm$ 10 % (1 meter)
- Lifetime > 50 000 hours (L90B10)
- Color Rendering Index CRI > 80
- High quality LED (MacAdams < 3)
- Dimmable 1/10-100%
- Lean design
- 2 years guarantee
- Suitable for all Treston and various other industrial workbenches
- Enclosure protection IP20



- ✓ Adjustability helps to find optimal lighting conditions.
- ✓ Timeless design brings functional beauty to industrial environments and it is never out of style.
- ✓ Easy and fast to install – just click, slide and screw.
- ✓ High-quality LED lights with high-quality drivers are care-free for years to come. Low maintenance, just keep them clean!
- ✓ Designed and manufactured in Finland.



## Treston NaturLite LED Wing 500

- Versatile task light
- Working area with or without shadows
- Also suitable in the middle of the table

# Optimal light for industrial environments:

## Treston IntoLite LED



- ✓ Good quality, bright and long lasting light.
- ✓ Light with basic features and capability to give optimal light to workstation.

| Name                        | Control                        | Colour temperature | Illuminance ±10% (@1 meter) | Luminous flux | Power | Size W x D x H mm | Suitability  | Code   |
|-----------------------------|--------------------------------|--------------------|-----------------------------|---------------|-------|-------------------|--|--------|
| <b>Treston IntoLite LED</b> | Touch button switch for ON/OFF | 4000K              | 1800 lux ±10%               | 3800 lm       | 36W   | 850 x 67 x 80     | All Treston and various other industrial workbenches | TIL850 |

**Common features:** Lifetime > 50 000 hours (L70B10), 2 years guarantee, Enclosure protection IP20

### Compatibility with light and balancer rails

|   | Module / suitable for | Front profile width mm | Code      | Compatible lighting units         |
|---|-----------------------|------------------------|-----------|-----------------------------------|
| Light and balancer rail<br>(Concept, QuatreX, TED, Quick Edge and TP benches) | 2 x M500              | 1000                   | 91849001P | TNL900, TIL850                    |
|   | 2 x M500/1500         | 1500                   | 91849002P | TNL900, TNL1200, TNL1200P, TIL850 |
|   | 4 x M500              | 2000                   | 91849003P | TNL900, TNL1200, TNL1200P, TIL850 |
|   | M750                  | 750                    | 91849004P | -                                 |
|   | M750/900              | 900                    | 91849013P | TNL900, TIL850                    |
|   | M750/1500             | 1500                   | 91849005P | TNL900, TNL1200, TNL1200P, TIL850 |
|   | 2 x M750              | 1500                   | 91849006P | TNL900, TNL1200, TNL1200P, TIL850 |
|   | 3 x M750              | 2250                   | 91849012P | TNL900, TNL1200, TNL1200P, TIL850 |
|   | M900                  | 900                    | 91849007P | TNL900, TIL850                    |
|   | 2 x M900              | 1800                   | 91849008P | TNL900, TNL1200, TNL1200P, TIL850 |
|   | M900/1500             | 1500                   | 91849009P | TNL900, TNL1200, TNL1200P, TIL850 |
|   | M1200                 | 1200                   | 91849010P | TNL900, TNL1200, TNL1200P, TIL850 |
|   | M1350                 | 1350                   | 91849011P | TNL900, TNL1200, TNL1200P, TIL850 |
| Support bracket HSB<br>(WB and QuatreX benches)                               | AL2X110W              | 1073                   | HSB110    | TNL900, TIL850                    |
|   | AL2X150W              | 1500                   | HSB150    | TNL900, TNL1200, TNL1200P, TIL850 |
|   | AL2X180W              | 1800                   | HSB180    | TNL900, TNL1200, TNL1200P, TIL850 |
| Tool and lighting support KT<br>(TPH benches)                                 | TPH712                | 1200                   | KT120     | TNL900, TNL1200, TNL1200P, TIL850 |
|   | TPH715/915, TPB915    | 1500                   | KT150     | TNL900, TNL1200, TNL1200P, TIL850 |
|   | TPH718/918, TPB918    | 1800                   | KT180     | TNL900, TNL1200, TNL1200P, TIL850 |

# Magnifying lamp

## Treston Wave LED ESD



- ✓ Lamp can be easily adjusted to desired position thanks to very precise and flexible 3-joint arm.
- ✓ Lamp offers shadow-free magnification with light coming from both sides.
- ✓ Wave LED ESD is suitable for use in EPA-areas.
- ✓ Suitable for all Treston Workbenches and other manufacturers' workbenches

| Name                        | Control                                   | Colour temperature | Illuminance ±10% (@1 meter) | Luminous flux | Power | Size W x D x H mm                                       | Fixing                            | Code    |
|-----------------------------|---|--------------------|-----------------------------|---------------|-------|---|-----------------------------------|---------|
| <b>Treston Wave LED ESD</b> | 2-sided touch button with 4 level dimming | 4000K              | 1500 lx                     | 764 lm        | 13W   | Lamp 227 x 225 x 40 mm, 3-joint arm length 500 + 550 mm | Table clamp (max thickness 72 mm) | TWL ESD |

**Common features:** Lifetime > 50 000 hours, 5 years guarantee, Enclosure protection IP20. Power cord 1,7m with Schuko-plug CEE7/7.

# Industrial chairs

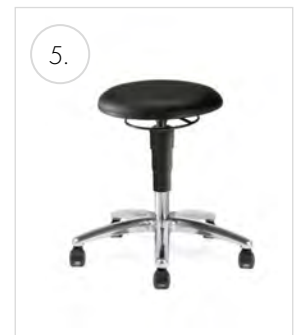
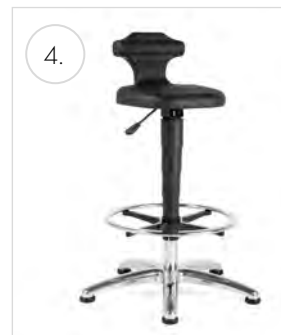
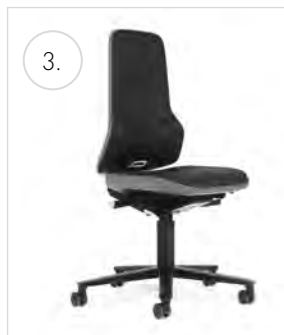

| Code ESD   | Description / Upholstery / Colour                      | Martindale | Seat height, mm* | Seat width, mm | Seat depth, mm | Backrest height, mm | Weight, kg |
|--|--|------------|------------------|----------------|----------------|---------------------|------------|
| <b>1. Treston Ergo chairs</b>  |  |            |                  |                |                |                     |            |
| <i>With conductive soft dual-wheel safety castors with load-sensitive brakes. High version with foot ring and conductive glides.</i> |  |            |                  |                |                |                     |            |
| a)   | C20PU-ESD Treston Ergo 20 polyurethane black ESD       |            | 440-620          | 440            | 410            | 380                 | 13,0       |
| b)   | C25PU-ESD Treston Ergo 25 polyurethane black ESD       |            | 580-850          | 440            | 410            | 380                 | 15,0       |
| c)   | C30AL-ESD Treston Ergo 30 artificial leather black ESD | 50.000     | 440-620          | 460            | 470            | 460                 | 13,0       |
| d)   | C30BL-ESD Treston Ergo 30 fabric black ESD             | 40.000     | 440-620          | 460            | 470            | 460                 | 13,0       |
| e)   | C35BL-ESD Treston Ergo 35 fabric black ESD             | 40.000     | 530-800          | 460            | 470            | 460                 | 15,0       |
| <b>2. Treston Plus chairs</b>  |  |            |                  |                |                |                     |            |
| <i>With conductive soft dual-wheel safety castors with load-sensitive brakes.</i>  |  |            |                  |                |                |                     |            |
| a)   | C40AL-ESD Treston Plus 40 artificial leather black ESD | 50.000     | 450-600          | 460            | 410-470        | 600                 | 19,5       |
| b)   | C40BL-ESD Treston Plus 40 fabric black ESD             | 40.000     | 450-600          | 460            | 410-470        | 600                 | 19,5       |
| <b>3. Neon chairs</b>  |  |            |                  |                |                |                     |            |
| <i>With conductive soft dual-wheel safety castors with load-sensitive brakes.</i>  |  |            |                  |                |                |                     |            |
|  | C50BL-G-ESD Neon 50 fabric black ESD grey strips       | 40.000     | 450-620          | 470            | 420-480        | 570                 | 18,0       |
| <b>4. Flex standing rests</b>  |  |            |                  |                |                |                     |            |
| <i>High version with foot ring and conductive glides.</i>  |  |            |                  |                |                |                     |            |
|  | C19PU-ESD Flex 19 polyurethane black ESD               |            | 510-780          | 360            | 380            | 200                 | 13,0       |
| <b>5. Stools</b>   |  |            |                  |                |                |                     |            |
| <i>With conductive soft dual-wheel safety castors with load-sensitive brakes.</i>  |  |            |                  |                |                |                     |            |
|  | C15AL-ESD Stool 15 artificial leather black ESD        | 50.000     | 460-630          | 400            | 400            |                     | 8,0        |

\*According to the DIN 68877, the seat height is measured from the floor to the centre of the seat with a 64-kg load. The maximum load capacity of the chairs is 120 kg.





| Code ESD  | Description / Upholstery / Colour       | Martindale | Seat height, mm* | Seat width, mm | Seat depth, mm | Backrest height, mm | Weight, kg |
|---|---|------------|------------------|----------------|----------------|---------------------|------------|
| <b>6. Saddle chairs</b>   |   |            |                  |                |                |                     |            |
| <i>With conductive soft dual-wheel safety castors with load-sensitive brakes.</i> |   |            |                  |                |                |                     |            |
| a) SADDLE G ESD   | Saddle chair fabric grey ESD            | > 50.000   | 575-820          | 420            | 350            |                     | 7,0        |
| b) SADDLE AL ESD  | Saddle chair articial leather ESD black |            | 575-820          | 420            | 350            |                     | 7,0        |

\*According to the DIN 68877, the seat height is measured from the floor to the centre of the seat with a 64-kg load. The maximum load capacity of the chairs is 120 kg.

**Accessories for chairs**

| Product   | Description  | Code ESD  |
|---|--|-----------|
| High glide set  | Abrasion-resistant plastic glides have a large surface area and offer superb level of stability. The glides can be retrofitted to of all our chairs.   | CGLIH-ESD |
| Soft castor set for hard floor                            | Dual-wheel safety castors are equipped with load-sensitive brakes, which means that the castors will brake when unloaded. As a standard, we supply soft castors for hard floors, but hard castors for soft floors need to be ordered separately. | CSCAS-ESD |
| Hard castor set for soft floor                            |  | CHCAS-ESD |
| Soft Stop&Go castor set for hard floors                   | In case the high chair needs to be moved around the workplace, Stop&Go castors will provide a safe solution. These castors will brake as soon as they are loaded, but when not loaded, the chair is easy to move around.                         | CSTOP-ESD |
| 4D ESD armrests for Treston Ergo ESD and Treston Plus ESD | Adjustment of height, width and depth with the possibility to swivel.  | ARE-ESD   |
| 4D armrests for Neon                                      | Adjustment of height, width and depth with the possibility to swivel.  | ARN-ESD   |
| Chrome-plated foot ring                                   | Foot ring can also be retrofitted to our lower chair models by attaching it to the chair column. Can be used on both ESD and non-ESD models. The height can be easily adjusted without any tools.  | CRING     |

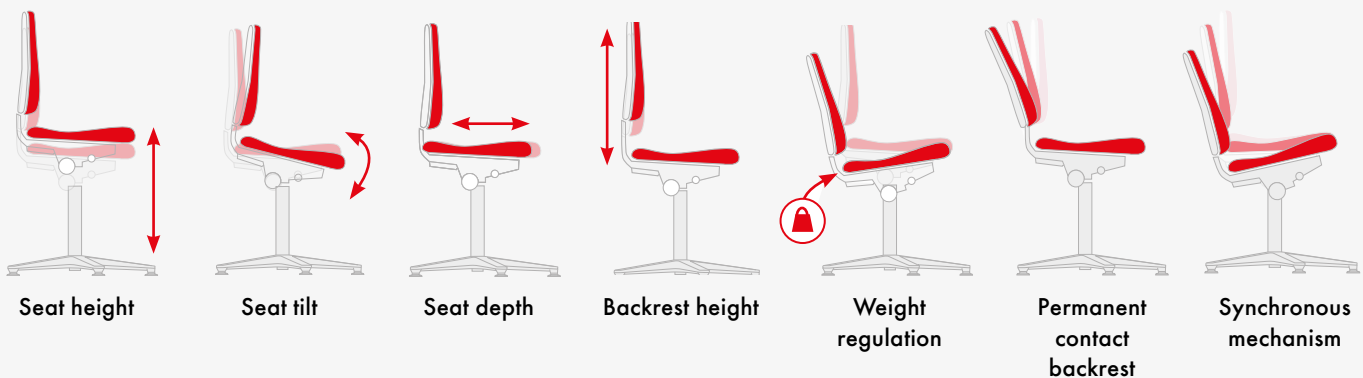

| Adjustments and features | Treston Ergo | Treston Plus | Neon | Stool | Saddle chair | Flex – standing rest |
|--------------------------|--------------|--------------|------|-------|--------------|----------------------|
| Seat height              | ✓            | ✓            | ✓    | ✓     | ✓            | ✓                    |
| Seat tilt                | ✓            | ✓            | ✓    |       | ✓            |                      |
| Seat depth               |              | ✓            | ✓    |       |              |                      |
| Backrest height          | ✓            | ✓            | ✓    |       |              |                      |
| Contact backrest         | ✓            |              |      |       |              |                      |
| Synchro mechanism        |              | ✓            | ✓    |       |              |                      |
| Arm rests as an option   | ✓            | ✓            | ✓    |       |              |                      |
| Changeable upholstery    |              |              | ✓    |       |              |                      |



# Trolleys



150 kg

## Universal trolley WTR

Most often combined with WB workstations to provide extra storage space. A good adjustable PC station, measuring station or mobile storage, best suitable for moving equipment around the workstation.



300 kg

## Industrial Multi trolley

This trolley can be equipped with shelves, tops and other module-sized accessories to fit any application, such as transportation or tool storage. The trolleys support heavy loads, but they are easy to move as well.



150 / 300 kg

## Adjustable trolley TRTA

For general use wherever a good transportation and storage solution is needed. Two or four shelves available; height of the shelves can be adjusted. Mesh panels can be installed at the ends or on the sides. Also a SMD reel holder version available.



12 / 25 kg

## Mobile workstation MLC

An ergonomic and versatile tool with key qualities such as light weight, small size and excellent mobility. Used wherever a laptop is needed on the go.



90 kg

## Storage trolley

Simple solution for mobile storage. The shelves are fitted with rubber mats and the middle shelf is adjustable.



150 kg

## Concept trolley

Most often combined with Concept and WB workstations to provide extra work and storage space. Lower shelf is integrated. Can be equipped with an additional shelf or drawer unit 30 series.



150 kg

## SAP trolley

Most often combined with TP workstations to provide extra workspace. Can be equipped with a lower shelf, an extra shelf and a handle, available separately.



300 kg

## Bin and cabinet trolleys

The bin and cabinet trolleys can be equipped with Treston stacking bins and bin cabinets based on own needs. Trolleys enable supplies and parts to be moved smoothly to wherever they are needed.

# Universal trolley WTR

A good quality, versatile trolley, PC-station, measuring station or mobile storage trolley. Modern industrial design.

The standard trolley has 3 shelves (TS605 ESD), size 650 x 530 mm. Height adjustment of shelves is by allen-key. The vertical profiles are of aluminium. Frames are of epoxy powder coated steel: light grey RAL 7035. The worktops are of 25 mm semi-conductive laminated chipboard particle board. Four swivel castors (Ø 125 mm) two of which have brakes, overall height of castor 141 mm.



## Universal trolley WTR

| Name                 | Size<br>W x D x H mm                               | Max load kg | Code ESD   |
|----------------------|--|-------------|------------|
| 1. Universal trolley | 660 x 650 x 1415                                   | 150         | WTR140 ESD |
| 2. Extra shelf       | 530 x 650  | 50          | TS605 ESD  |
| 3. Adjustable shelf* | 530 x 650  | 50          | TAS605 ESD |
| 4. Bin profile       | Length 525   |             | BP50 ESD   |
| 5. Keyboard tray NT  | 525 x 399 x 133 (outer)<br>500 x 250 x 110 (inner) |             | NT 500 ESD |

\*Continuous adjustment for depth, height and angle.



# Treston Industrial Multi trolley

Multi trolleys provide an ergonomic mobile workstation. Multi trolleys are available in three different widths: M500, M750 and M900. This means that all our module-sized accessories can be used with the trolleys.

The sturdy shelves can be height-adjusted and tilted. Shelves come with raised edges which keep the load in place. ESD-mats for shelves available separately.

Multi trolleys support heavy loads, but they are easy to move as well, making it simple to transport heavy equipment, such as measuring units. They are equipped with four swivel castors (Ø 125 mm), two of which have brakes.

## Treston Industrial Multi trolley with adjustable shelves

| Description             | Module | Size<br>W x D x H mm | Max<br>load kg | Code ESD     |
|-------------------------|--------|----------------------|----------------|--------------|
| 1. 4 adjustable shelves | M500   | 540 x 760 x 1790     | 300            | TMTH5-002-49 |
|                         | M750   | 790 x 760 x 1790     | 300            | TMTH7-002-49 |
|                         | M900   | 943 x 760 x 1790     | 300            | TMTH9-002-49 |
| 2. 2 adjustable shelves | M500   | 540 x 760 x 1150     | 300            | TMTL5-002-49 |
|                         | M750   | 790 x 760 x 1150     | 300            | TMTL7-002-49 |
|                         | M900   | 943 x 760 x 1150     | 300            | TMTL9-002-49 |

Bottom shelf and mats for shelves, see page 63.



## Treston Industrial Multi trolley with shelves

| Description  | Module | Size<br>W x D x H mm | Max<br>load kg | Code ESD     |
|--------------|--------|----------------------|----------------|--------------|
| 3. 4 shelves | M500   | 540 x 760 x 1790     | 300            | TMTH5-001-49 |
|              | M750   | 790 x 760 x 1790     | 300            | TMTH7-001-49 |
|              | M900   | 943 x 760 x 1790     | 300            | TMTH9-001-49 |
| 4. 2 shelves | M500   | 540 x 760 x 1150     | 300            | TMTL5-001-49 |
|              | M750   | 790 x 760 x 1150     | 300            | TMTL7-001-49 |
|              | M900   | 943 x 760 x 1150     | 300            | TMTL9-001-49 |

Bottom shelf and mats for shelves, see page 63.



**1. Treston Industrial Multi trolley with perforated panels**

| Module | Size<br>W x D x H mm | Max load<br>kg | Code ESD     |
|--------|----------------------|----------------|--------------|
| M750   | 790 x 760 x 1790     | 300            | TMTH7-005-49 |
| M900   | 943 x 760 x 1790     | 300            | TMTH9-005-49 |

**2. Treston Industrial Multi trolley with tilted perforated panels**

| Module | Size<br>W x D x H mm | Max load<br>kg | Code ESD |
|--------|----------------------|----------------|----------|
| -      | 820 x 760 x 1860     | 300            | TMTA-49  |



# Industrial Multi trolley frame and accessories

- Equip your trolleys with shelves, tops and other accessories to fit any application, such as transportation or tool storage.
- All trolleys are equipped with four swivel castors (Ø 125 mm), two of which have brakes.
- Can easily be customised with a wide range of accessories, to meet individual needs.

**Treston Industrial Multi trolley frame**

| Name       | Module | Size<br>W x D x H mm | Max load<br>kg | Code ESD  |
|------------|--------|----------------------|----------------|-----------|
| Frame High | M500   | 540 x 760 x 1790     | 300            | TMTFH5-49 |
| Frame High | M750   | 790 x 760 x 1790     | 300            | TMTFH7-49 |
| Frame High | M900   | 943 x 760 x 1790     | 300            | TMTFH9-49 |
| Frame Low  | M500   | 540 x 760 x 1150     | 300            | TMTFL5-49 |
| Frame Low  | M750   | 790 x 760 x 1150     | 300            | TMTFL7-49 |
| Frame Low  | M900   | 943 x 760 x 1150     | 300            | TMTFL9-49 |



**Bottom shelf**

| Name                    | Module | Size W x D x H mm | Max load kg | Code ESD  |
|-------------------------|--------|-------------------|-------------|-----------|
| Bottom shelf M500 x 728 | M500   | 460 x 728 x 33    | 100         | TMTLS5-49 |
| Bottom shelf M750 x 728 | M750   | 710 x 728 x 33    | 100         | TMTLS7-49 |
| Bottom shelf M900 x 728 | M900   | 863 x 728 x 33    | 100         | TMTLS9-49 |



**Steel shelf**

| Name                              | Module | Size W x D x H mm | Max load kg | Code ESD |
|-----------------------------------|--------|-------------------|-------------|----------|
| Steel shelf M500 x 650 + brackets | M500   | 468 x 650 x 33    | 100         | TMTS5-49 |
| Steel shelf M750 x 650 + brackets | M750   | 718 x 650 x 33    | 100         | TMTS7-49 |
| Steel shelf M900 x 650 + brackets | M900   | 871 x 650 x 33    | 100         | TMTS9-49 |



**Adjustable shelf, stepless tilt**

| Name                        | Module | Size W x D x H mm | Max load kg | Code ESD  |
|-----------------------------|--------|-------------------|-------------|-----------|
| Adjustable shelf M500 x 650 | M500   | 468 x 650 x 37    | 100         | TMTAS5-49 |
| Adjustable shelf M750 x 650 | M750   | 718 x 650 x 37    | 100         | TMTAS7-49 |
| Adjustable shelf M900 x 650 | M900   | 871 x 650 x 37    | 100         | TMTAS9-49 |



**Adjustable shelf, stepless depth and tilt**

| Name                        | Module | Size W x D x H mm | Max load kg | Code ESD   |
|-----------------------------|--------|-------------------|-------------|------------|
| Adjustable shelf M500 x 650 | M500   | 468 x 650 x 37    | 50          | TMTSAS5-49 |
| Adjustable shelf M750 x 650 | M750   | 718 x 650 x 37    | 50          | TMTSAS7-49 |
| Adjustable shelf M900 x 650 | M900   | 871 x 650 x 37    | 50          | TMTSAS9-49 |



**ESD mats for shelves**

| Suitability                               | Module | Size W x D mm | Code ESD  |
|---|--------|---------------|-----------|
| Lower shelf TMTLS5-49                     | M500   | 455 x 723     | 725750-49 |
| Lower shelf TMTLS7-49                     | M750   | 705 x 723     | 725747-49 |
| Lower shelf TMTLS9-49                     | M900   | 858 x 723     | 725748-49 |
| Steel shelf TMTS5-49                      | M500   | 463 x 645     | 725746-49 |
| Steel shelf TMTS7-49                      | M750   | 713 x 645     | 725743-49 |
| Steel shelf TMTS9-49                      | M900   | 866 x 645     | 725744-49 |
| Adjustable shelf TMTAS5-49 and TMTSAS5-49 | M500   | 428 x 600     | 860821-00 |
| Adjustable shelf TMTAS7-49 and TMTSAS7-49 | M750   | 678 x 600     | 860318-00 |
| Adjustable shelf TMTAS9-49 and TMTSAS9-49 | M900   | 831 x 600     | 860320-00 |



**Industrial Multi trolley accessories**

| Name                 | Size W x D x H mm                            | Max load kg | Code ESD   |
|----------------------|--|-------------|------------|
| Waste basket holder* |  |             | 835 773-49 |
| Paper roll holder*   | Roll dimensions max: width 240 mm, Ø 230 mm) |             | 860 310-49 |
| Flow-through shelf** | 718 x 835 x 61                               | 150         | 890 710-49 |

For perforated panels, see page 41.

\* fixing to upright

\*\*including brackets





# Adjustable trolley TRTA

For general use in workshops, offices, production areas and hospitals. Shelves are powder coated steel, RAL 7035 ESD, height 28 mm. All shelves are individually adjustable. The structure is light but sturdy. The end-frames of the trolley are made of round, powder coated steel tube (25 mm). Four swivel castors (Ø 125 mm), two of which have brakes.



## Adjustable trolley TRTA

| Name              | Size<br>W x D x H mm | Shelf size<br>W x D mm | Max<br>load kg | Code ESD     |
|-------------------|----------------------|------------------------|----------------|--------------|
| 2-shelf trolley*  | 890 x 530 x 1020     | 800 x 430              | 150            | TRTA4082 ESD |
| 2-shelf trolley*  | 1090 x 530 x 1020    | 1000 x 430             | 150            | TRTA4102 ESD |
| 2-shelf trolley*  | 890 x 630 x 1020     | 800 x 530              | 150            | TRTA5082 ESD |
| 2-shelf trolley*  | 1090 x 630 x 1020    | 1000 x 530             | 150            | TRTA5102 ESD |
| 4-shelf trolley** | 1090 x 530 x 1515    | 1000 x 430             | 300            | TRTA4104 ESD |
| 4-shelf trolley** | 1090 x 630 x 1515    | 1000 x 530             | 300            | TRTA5104 ESD |

Max load 50 kg / shelf.

\* Shelf adjustments between 200-770 mm

\*\* Shelf adjustments between 200-1340 mm

## Extra shelves TRHA

| Name        | Shelf size W x D mm | Max load kg | Code ESD    |
|-------------|---------------------|-------------|-------------|
| Extra shelf | 800 x 430           | 50          | TRHA408 ESD |
| Extra shelf | 1000 x 430          | 50          | TRHA410 ESD |
| Extra shelf | 800 x 530           | 50          | TRHA508 ESD |
| Extra shelf | 1000 x 530          | 50          | TRHA510 ESD |

## End mesh panels NET2

| Name           | Size W x D mm | Set            | Code ESD |
|----------------|---------------|----------------|----------|
| End mesh panel | 604 x 364     | Incl. 2 panels | NET2     |

The mesh panels can be installed at the ends of the trolley or on the sides. An angle bracket is set on the edge of the upper and lower shelf and the mesh is screwed into place. The 4-shelf trolley can hold 2 mesh panels on top of each other.

## Document holder DSA4

| Name            | Size | Code ESD |
|-----------------|------|----------|
| Document holder | A4   | DSA4 ESD |

Semiconductive epoxy powder coated steel. Includes two magnets.

## Low M-divider hoops LDH

| Name          | Size      | Code ESD |
|---------------|-----------|----------|
| Divider hoops | 460 x 315 | LDH      |

Steplessly adjustable. 4 pcs per set. M-shape (the lowest point 105 mm from shelf). Suitable only 430 mm deep shelves.



Low M-divider hoops LDH

Document holder

# Reel holder trolley RRT

The adjustable reel holder trolley is compatible with SMD reels, and suitable for transport and stocking of them. All parts are powder coated steel, RAL 7035 ESD. The trolley has four perforated steel shelves, 1090 x 460 x 28 mm. All shelves are individually adjustable between 200-1605 mm.

The zinc plated reel racks that fit into the shelves are to be ordered separately. The structure is light but sturdy. The end-frames of the trolley are made of round, powder coated steel tube (25 mm). Four turning castors with brakes (Ø 125 mm). The load capacity of one shelf is 50 kg, and the load capacity of the trolley is 200 kg.

## Reel holder trolley RRT

| Name                   | Size<br>W x D x H mm | Max<br>load kg | Code ESD |
|------------------------|----------------------|----------------|----------|
| 1. Reel holder trolley | 1100 x 530 x 1780    | 200            | RRT ESD  |
| 2. Reel rack           | 960 x 426 x 254      | 50             | RR ESD-Z |
| 3. Document holder     | A4                   |                | DSA4 ESD |

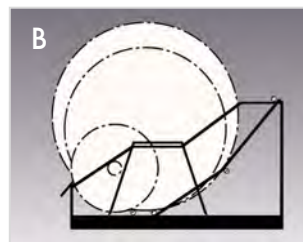
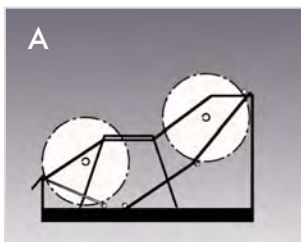
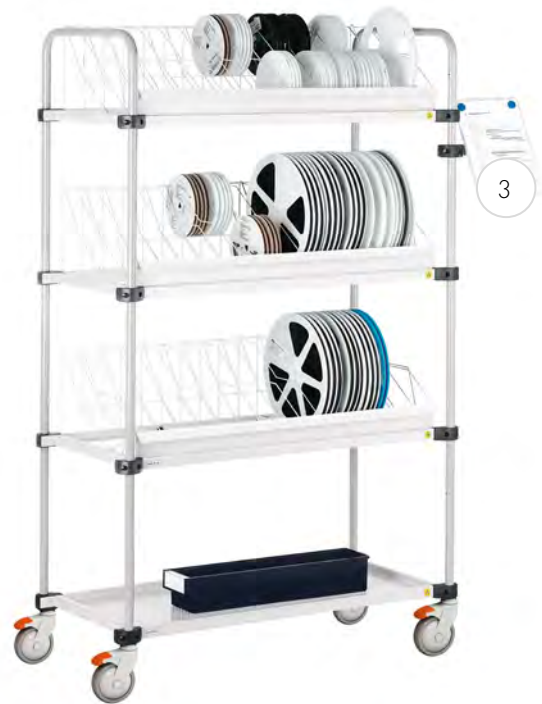

In picture A: Side view of spools and reel racks. The capacity of one rack is 30 fixed compartments for 7" spools of 60 mm width.

In picture B: Side view of spools and reel racks. The capacity of one rack is 15 fixed compartments for 13" and 15" spools of 60 mm width.

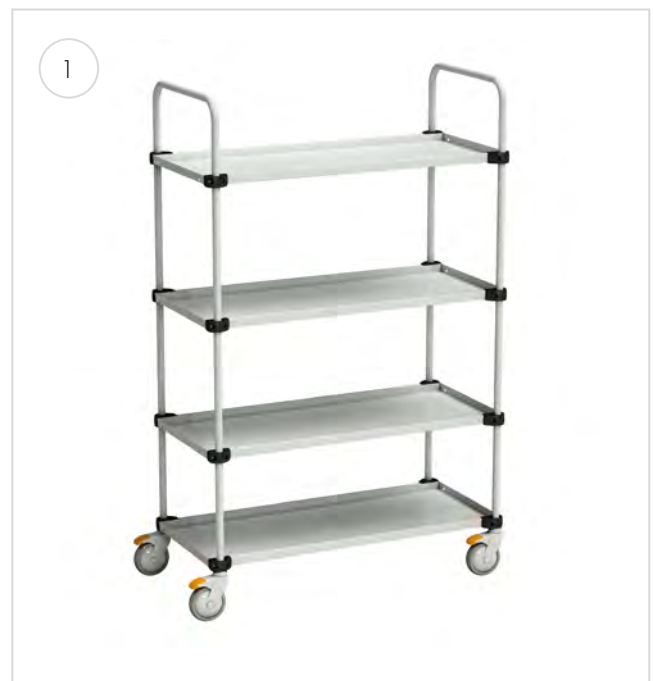

# Mobile workstations

**MLC mobile workstation** is a light, ergonomic and easy-to-move workstation. The mobile workstation moves and turns effortlessly even in tight spaces. A laptop computer can be placed on the worktop or underneath it, in which case only the screen is visible. A wide range of accessories is available, with all the necessary supplies included.

- An ergonomic workstation that is light to move around - aluminium frame, steel legs
- Standard features include a laminated worktop and a lockable computer compartment with holes for wires
- Four swivel castors (Ø125 mm), two with brakes

**MLCT mobile height adjustable work surface** is a compact sized additional work surface with easy gas spring height adjustment. It is ideal for tight spaces and tasks where easy manoeuvrability is a must. Optimal for handling light loads and small sized objects. Ideal also for laptop use. Suitable for technical and EPA environments where easy ergonomics and mobility are required.

- Easy to move around due to the light construction - aluminium frame, symmetric steel legs
- Accessories available: Accessory box underneath the table top, accessories basket to the frame and a folder holder
- Four swivel castors (Ø100 mm), two with brakes



MLC mobile workstation



MLCT mobile height adjustable work surface

## Mobile workstations

| Name                                  | Size W x D mm | Height mm* | Top size mm    | Max load kg | Code ESD       |
|---------------------------------------|---------------|------------|----------------|-------------|----------------|
| Mobile workstation                    | 590 x 540     | 800-1200   | 520 x 370 x 25 | 12          | MLC 405PG ESD  |
| Mobile height adjustable work surface | 600 x 500     | 760-1185   | 580 x 490 x 25 | 25**        | MLCT 605PG ESD |

\*Height is adjusted by gas spring.

\*\* 150 N gas spring lightens the load with app. 10 kg upon lifting.

## Mobile workstation accessories

| Name                 | Description   | Suitability | Code ESD    |
|----------------------|---|-------------|-------------|
| 1. Binder mount      | Fits a single 75 mm wide binder.                          | MLC, MLCT   | FH1         |
| 2. LCD support arm   | For the attachment of MH and MY supports. Max 22" screen. | MLC         | MS          |
| 3. Accessory box ESD | With ESD shelf bin 4020-4ESD.                             | MLCT        | AB4020-4ESD |



# Trolleys for additional workspace

**Storage trolley** is an easy solution for mobile storage, the storage trolley has an adjustable middle shelf, and the shelves are fitted with ESD or standard rubber mats.

**SAP trolley** provides extra workspace for the TP workbench. Lower self, extra shelf and handle are available separately. Height adjustment with allen key between 650-900 mm.

**Concept trolley** provides extra workspace for Concept and WB workbenches. Lower shelf is integrated. Can be equipped with an additional shelf or drawer unit 30 series. Height adjustment with allen key between 650-900 mm.



Storage trolley

## Trolleys for additional workspace

| Name                            | Size<br>W x D x H mm | Max<br>load kg | Code ESD    |
|---------------------------------|----------------------|----------------|-------------|
| Storage trolley                 | 650 x 450 x 775      | 3 x 30         | 852 773-49  |
| SAP trolley                     | 700 x 500            | 150            | SAP507 ESD  |
| SAP trolley                     | 1000 x 700           | 150            | SAP710 ESD  |
| Lower shelf for SAP trolley     | 700 x 500            | 40             | AT507 ESD   |
| Lower shelf for SAP trolley     | 1000 x 700           | 40             | AT710 ESD   |
| Extra shelf for SAP trolley     | 700 x 500            | 40             | LT507 ESD   |
| Extra shelf for SAP trolley     | 1000 x 700           | 40             | LT710 ESD   |
| Handle for SAP trolley          | depth 500            |                | PUSH50      |
| Handle for SAP trolley          | depth 700            |                | PUSH70      |
| Concept trolley                 | 500 x 700 x 650-900  | 150            | CONT705-49  |
| Extra shelf for Concept trolley | 400 x 500            | 25             | CONTS504-49 |
| Drawer unit 30/15               | 300 x 454 x 150      | 10             | 859 330-49  |
| Drawer unit 30/22               | 300 x 454 x 220      | 10 /<br>drawer | 859 340-49  |
| Drawer unit fastening set       |                      |                | 890 653-49  |

All the light-duty trolleys are equipped with four swivel castors (ø 100 mm), two of which have brakes.



SAP trolley with AT lower shelf, LT extra shelf and PUSH handle



Concept trolley, extra shelf and drawer unit 30/15

# Cabinet trolley for storage cabinets

- Double-sided ESD-protected trolley for small-part storage cabinets
- Steel frame and fixed bottom shelf powder-coated with a semiconductive ESD paint (light grey, RAL 7035).
- Maximum eight small-parts cabinets, 4 on each side, to be ordered separately
- Four swivel ESD-castors (Ø 100 mm), two with brakes.
- Module M750, all the upright tube accessories are available



## Cabinet trolley BT-550B ESD

| Name            | Size W x D x H mm | Max load kg | Code ESD    |
|-----------------|-------------------|-------------|-------------|
| Cabinet trolley | 790 x 760 x 1770  | 300         | BT-550B ESD |

Height of the fixing rails can be adjusted easily without tools. Height adjustable ergonomic push handle.

## Suitability

| Type     | Number of drawers | Dimensions W x D x H mm |
|----------|-------------------|-------------------------|
| 551-4ESD | 48 pcs            | 69 x 170 x 40           |
| 554-4ESD | 24 pcs            | 92 x 170 x 62           |

# Stacking bin trolley

- Double-sided ESD-protected trolley for stacking bins
- Steel frame and fixed bottom shelf powder-coated with a semiconductive ESD paint (light grey, RAL 7035).
- Up to 112 stacking bins can be attached to one trolley, must be ordered separately
- Height adjustable ergonomic push handle
- Sixteen step-by-step height adjustable bin rails, eight bin rails per side, length of bin rails 742mm
- Height of the bin rails can be adjusted easily without tools
- Four swivel ESD-castors (Ø 100 mm), two with brakes
- Load capacity for bin rail 50 kg, for trolley 300 kg
- Module M750, all the upright tube accessories are available.



## Trolley BT-170B ESD

| Name                 | Size W x D x H mm | Max load kg | Code ESD    |
|----------------------|-------------------|-------------|-------------|
| Stacking bin trolley | 790 x 760 x 1770  | 300         | BT-170B ESD |

## Suitability

| Stacking bin | Quantity/rail | Max. quantity/stand |
|--------------|---------------|---------------------|
| 1015         | 7 pcs         | 112 pcs             |
| 1520         | 5 pcs         | 80 pcs              |
| 1525         | 5 pcs         | 80 pcs              |
| 1930         | 4 pcs         | 64 pcs              |



# Drawer units



## Light steel cabinet LMC

These steel cabinets are an ideal way of providing individual secure storage for your staff. Drawers are mounted on telescopic ball race slides. Four cabinet sizes, including one drawer/cupboard combination.



## Drawer units 30 and 35

These drawer units are fastened under a workbench to provide storage space. Choose from single drawer, two drawers or drawer cabinet. If additional drawers are needed, they can be easily attached to each other. The drawers can be locked to protect the contents.



## Drawer unit 45

Choose from two frame heights: 56 or 66 cm, with a plinth for a stand alone solution or with castors for a trolley version. The drawer unit 45 can also be attached under the worktop. All the drawer units have central locking.

# Light steel cabinet **LMC**

These steel cabinets are an ideal way of providing individual secure storage for your staff. Drawers are mounted on telescopic ball race slides. Four cabinet sizes, including one drawer/cupboard combination. The cabinet frames are epoxy powder coated steel; drawer fronts are composite board with aluminium handles. Mount on benches with brackets (included).

Suitable for **WB/TP/TPH** workbenches and **SAP/WTR** trolleys



**Light steel cabinet, load capacity 15 kg/drawer, 70 % opening**

| Code ESD                           | LMC01 ESD       | LMC02 ESD       | LMC04 ESD       | LMC04D ESD                                       |
|------------------------------------|-----------------|-----------------|-----------------|--|
| Outer dims W x D x H mm            | 370 x 460 x 135 | 370 x 460 x 245 | 370 x 460 x 455 | 370 x 460 x 455                                  |
| Includes drawers (outer height mm) | 1 x 100         | 2 x 100         | 4 x 100         | 1 x 100 + cupboard, height 300 mm, open to right |

**Internal drawer dimensions: 278 x 438 x 75 mm**

## Cover LMCK2

| Description   | Code ESD |
|---|----------|
| Needed for mounting cabinets to WB benches and WTR trolley. | LMCK2    |

# Drawer units **30 and 35**

These drawer units are fastened under a workbench to provide storage space. Choose from single drawer, two drawers or drawer cabinet. If additional drawers are needed, they can be easily attached to each other. The drawers can be locked to protect the contents.

Drawer cabinet 35/47 is suitable for storing upright folders.



**Drawer units 30 and 35, load capacity 10 kg/drawer, 80 % opening**

|                                    | 30/15                     | 30/22                    | 35/47                      |
|------------------------------------|---------------------------|--------------------------|----------------------------|
| Code ESD                           | 859 330-49                | 859 340-49               | 860 972-49                 |
| Outer dims W x D x H mm            | 300 x 454 x 150           | 300 x 454 x 220          | 350 x 470 x 470            |
| Includes drawers (outer height mm) | 1 x 150                   | 2 x 110                  | 1 x 110 + cupboard, height |
| <b>Internal drawer dimensions:</b> | <b>255 x 400 x 120 mm</b> | <b>255 x 400 x 75 mm</b> | <b>300 x 400 x 70 mm</b>   |

**Fastening sets for drawer unit 30 and 35 (should be selected according to the type of the workbench)**

| Depth                          | 600 mm     | 700 mm     | 750 mm     | 800 mm     | 900 mm     |
|--------------------------------|------------|------------|------------|------------|------------|
| Concept, allen key adjustable  | 890 653-49 | -          | 890 653-49 | -          | 890 653-49 |
| Concept, hand crank adjustable | -          | -          | 890 653-49 | -          | 890 653-49 |
| Concept, motor adjustable      | -          | -          | 854 463-49 | -          | 854 463-49 |
| TED                            | -          | -          | -          | 855 057-49 | -          |
| TP / TPH                       | -          | 855 054-49 | -          | -          | 855 054-49 |
| WB                             | -          | -          | -          | 855 054-49 | -          |

Not adapted to Concept handcrank and motor adjustable bench (depth 600 mm).

# Drawer unit 45

Centrally locked high quality steel drawer units for storage of tools and small components. Mounted under workbenches with brackets. Also available with castors as a trolley version. Drawer units are epoxy powder coated in grey, RAL 7035. Central locking. Full width drawer handle in anodised aluminium. Smooth and quiet telescopic ball-race runners with 100 % opening of the drawers. Load-bearing capacity is 60 kg per drawer. Our drawer units are suitable for use in EPAs. The mobile trolleys are available in both ESD and non- ESD versions.

Drawers open 100% and their load capacity is 60 kg.

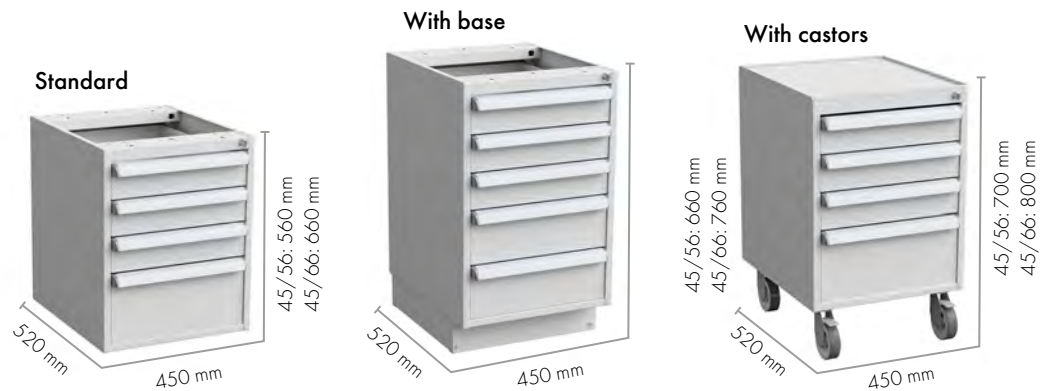

Load capacity 150 kg, 4 swivel castors (Ø 100 mm), 2 with brakes. The trolley version comes with a rubber mat that stops items from sliding on the surface.

- Choose the drawer unit according to your needs; with castors, base or no base.
- Drawer units with castors are also available as non ESD-versions (code 41 instead of 49).

| Internal drawer dimensions mm |                 |
|-------------------------------|-----------------|
| Outer height mm               | Inner height mm |
| 100                           | 90              |
| 150                           | 140             |
| 200                           | 190             |
| 300                           | 290             |

## 1. Drawer unit 45/14-1

| Drawers | Code ESD               |
|---------|------------------------|
| 100 x 1 | Standard<br>603 49 001 |

## 2. Drawer unit 45/26-1

| Drawers | Code ESD               |
|---------|------------------------|
| 100 x 2 | Standard<br>604 49 001 |



## 3. Drawer unit 45/56-2

| Drawers          | Code ESD Standard | Code ESD With base | Code ESD With castors |
|------------------|-------------------|--------------------|-----------------------|
| 100 x 2, 150 x 2 | 606 49 102        | 606 49 202         | 606 49 302            |



## 4. Drawer unit 45/56-3

| Drawers          | Code ESD Standard | Code ESD With base | Code ESD With castors |
|------------------|-------------------|--------------------|-----------------------|
| 100 x 3, 200 x 1 | 606 49 103        | 606 49 203         | 606 49 303            |

**5. Drawer unit 45/66-1**

| Drawers | Code ESD<br>Standard | Code ESD<br>With base | Code ESD<br>With castors |
|---------|----------------------|-----------------------|--------------------------|
| 100 x 6 | 607 49 101           | 607 49 201            | 607 49 301               |



**6. Drawer unit 45/66-2**

| Drawers          | Code ESD<br>Standard | Code ESD<br>With base | Code ESD<br>With castors |
|------------------|----------------------|-----------------------|--------------------------|
| 100 x 3, 150 x 2 | 607 49 102           | 607 49 202            | 607 49 302               |

**7. Drawer unit 45/66-6**

| Drawers          | Code ESD<br>Standard | Code ESD<br>With base | Code ESD<br>With castors |
|------------------|----------------------|-----------------------|--------------------------|
| 100 x 2, 200 x 2 | 607 49 106           | 607 49 206            | 607 49 306               |



**8. Drawer unit 45/66-7**

| Drawers | Code ESD<br>Standard | Code ESD<br>With base | Code ESD<br>With castors |
|---------|----------------------|-----------------------|--------------------------|
| 200 x 3 | 607 49 107           | 607 49 207            | 607 49 307               |

**Additional drawer units 45/56**

|              | 45/56-1    | 45/56-4    | 45/56-7    | 45/56-10   | 45/56-11   |
|--------------|------------|------------|------------|------------|------------|
| Standard     | 606 49 101 | 606 49 104 | 606 49 107 | 606 49 110 | 606 49 111 |
| With base    | 606 49 201 | 606 49 204 | 606 49 207 | 606 49 210 | 606 49 211 |
| With castors | 606 49 301 | 606 49 304 | 606 49 307 | -          | -          |
| 100          | x 5        | x 1        | -          | x 2        | -          |
| 150          | -          | -          | x 2        | -          | -          |
| 200          | -          | x 2        | x 1        | -          | x 1        |
| 300          | -          | -          | -          | x 1        | x 1        |

**Additional drawer units 45/66**

|              | 45/66-3    | 45/66-4    | 45/66-5    | 45/66-12   | 45/66-13   | 45/66-14   | 45/66-15   |
|--------------|------------|------------|------------|------------|------------|------------|------------|
| Standard     | 607 49 103 | 607 49 104 | 607 49 105 | 607 49 112 | 607 49 113 | 607 49 114 | 607 49 115 |
| With base    | 607 49 203 | 607 49 204 | 607 49 205 | 607 49 212 | 607 49 213 | 607 49 214 | 607 49 215 |
| With castors | 607 49 303 | 607 49 304 | 607 49 305 | -          | -          | -          | -          |
| 100          | x 1        | -          | x 4        | x 3        | -          | x 1        | -          |
| 150          | x 2        | x 4        | -          | -          | x 2        | -          | -          |
| 200          | x 1        | -          | x 1        | -          | -          | x 1        | -          |
| 300          | -          | -          | -          | x 1        | x 1        | x 1        | x 2        |

**Cabinet 45/56, door right**

|              | w/o lock   | with lock  |
|--------------|------------|------------|
| Standard     | 606 49 105 | 606 49 108 |
| With plinth  | 606 49 205 | 606 49 208 |
| With castors | 606 49 305 | 606 49 308 |

**Cabinet 45/56, door left**

|              | w/o lock   | with lock  |
|--------------|------------|------------|
| Standard     | 606 49 106 | 606 49 109 |
| With plinth  | 606 49 206 | 606 49 209 |
| With castors | 606 49 306 | 606 49 309 |



Cabinets include one bottom shelf and one adjustable shelf, shelf load capacity 50 kg.

**Drawer cabinet 45/66, door right**

| drawer 1 x 100 | w/o lock   | with lock  |
|----------------|------------|------------|
| Standard       | 607 49 108 | 607 49 110 |
| With plinth    | 607 49 208 | 607 49 210 |
| With castors   | 607 49 308 | 607 49 310 |

**Drawer cabinet 45/66, door left**

| drawer 1 x 100 | w/o lock   | with lock  |
|----------------|------------|------------|
| Standard       | 607 49 109 | 607 49 111 |
| With plinth    | 607 49 209 | 607 49 211 |
| With castors   | 607 49 309 | 607 49 311 |



Cabinets include one bottom shelf and one adjustable shelf, shelf load capacity 50 kg.

**Fastening sets for drawer unit 45 (should be selected according to the type of the workbench)**

| Depth                          | 600 mm     | 700 mm      | 750 mm     | 800 mm      | 900 mm      |
|--------------------------------|------------|-------------|------------|-------------|-------------|
| Concept, allen key adjustable  | 890 653-49 | -           | 890 653-49 | -           | 890 653-49  |
| Concept, hand crank adjustable | -          | -           | 890 653-49 | -           | 890 653-49  |
| Concept, motor adjustable      | -          | -           | 854 463-49 | -           | 854 463-49  |
| TP / TPH / TPB                 | -          | 855 055-49* | -          | -           | 855 055-49* |
| WB                             | -          | -           | -          | 855 055-49* | -           |
| Treston QuatreX                | -          | -           | 855 058-49 | -           | 855 058-49  |

Not adapted to Concept handcrank and motor adjustable bench (depth 600 mm).

\* Standard drawer unit models include fastening set. For drawer unit models with plinth the fastening set 855 055-49 is available only upon order.

For heavy loads we recommend adding a plinth or castors to the drawer unit.

**Cover**

| Description                                       | Code       |
|---|------------|
| Needed for mounting drawer unit 45 to WB benches. | 855 060-49 |



# Drawer interiors

**Divider set 1**

| Model                       | Code ESD   |
|-----------------------------|------------|
| Drawer 45/100               | 872 991-49 |
| Drawer 45/ 150 and 45/200   | 872 996-49 |
| 4 x horizontal dividers 375 |            |

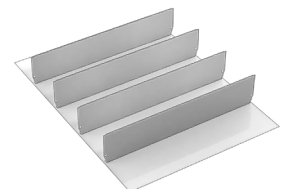
**Divider set 2**

| Model                                       | Code ESD   |
|---|------------|
| Drawer 45/100                               | 872 992-49 |
| Drawer 45/ 150 and 45/200                   | 872 997-49 |
| 1 x vertical divider, 8 x divider plate 185 |            |

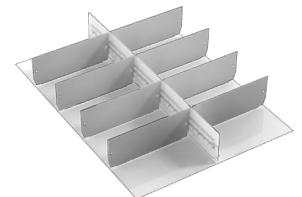
**Divider set 3**

| Model  | Code ESD   |
|--|------------|
| Drawer 45/100  | 872 993-49 |
| Drawer 45/ 150 and 45/200  | 872 998-49 |
| 1 x vertical divider, 4 x divider plate 125, 4 x divider plate 250 |            |

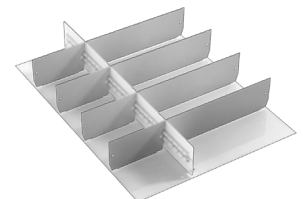
**Divider set 4**

| Model  | Code ESD   |
|--|------------|
| Drawer 45/100                                | 872 994-49 |
| Drawer 45/ 150 and 45/200                    | 872 999-49 |
| 2 x vertical divider, 12 x divider plate 125 |            |

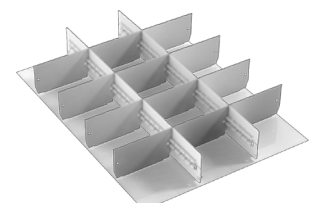



# Storage systems

## FiFo Flow Rack



### FiFo Flow Rack

| Name                                     | Suitability of bins   | Module | Size<br>W x D x H mm | Max<br>load kg | Code ESD      |
|--|---|--------|----------------------|----------------|---------------|
| 1 FiFo Flow Rack                         | 24 pcs Treston stacking bins 1940 or similar.                             | M900   | 933 x 805 x 1860     | 700            | TFR900-49     |
|  | 24 pcs Treston stacking bins 3040, 24 pcs 300 x 400 euroboxes or similar. | M1350  | 1385 x 805 x 1860    | 700            | TFR1350-49    |
| 2 FiFo Flow Rack,<br>rear extension      | 24 pcs Treston stacking bins 1940 or similar.                             | M900   | 933 x 735 x 1860     | 700            | TFR900RE-49   |
|  | 24 pcs Treston stacking bins 3040, 12 pcs 300 x 400 euroboxes or similar. | M1350  | 1385 x 735 x 1860    | 700            | TFR1350RE-49  |
| 3 FiFo Flow Rack,<br>side extension      | 24 pcs Treston stacking bins 1940 or similar                              | M900   | 933 x 805 x 1860     | 700            | TFR900SE-49   |
|  | 24 pcs Treston stacking bins 3040, 24 pcs 300 x 400 euroboxes or similar. | M1350  | 1385 x 805 x 1860    | 700            | TFR1350SE-49  |
| 4 FiFo Flow Rack,<br>side-rear extension | 24 pcs Treston stacking bins 1940 or similar.                             | M900   | 933 x 735 x 1860     | 700            | TFR900SRE-49  |
|  | 24 pcs Treston stacking bins 3040, 12 pcs 300 x 400 euroboxes or similar. | M1350  | 1385 x 735 x 1860    | 700            | TFR1350SRE-49 |

Rack includes 3 roller tops which are adjustable without any tools. Each roller top includes 8 pcs roller profiles and 3 pcs guide plates.

**Many other bin size options are suitable by adding or removing roller profiles and guide plates.**

### FiFo Flow Rack with steel shelves

| Name                             | Suitability of bins  | Module | Size<br>W x D x H mm | Max<br>load kg | Code ESD     |
|----------------------------------|--|--------|----------------------|----------------|--------------|
| FiFo Flow Rack,<br>steel shelves | 24 pcs Treston stacking bins 1940 or similar.  | M900   | 933 x 805 x 1860     | 700            | TFR900SS-49  |
|                                  | 32 pcs Treston stacking bins 3040, 300 x 400 euroboxes or similar. Alternatively 48 pcs Treston stacking bins 1940 or similar. | M1350  | 1385 x 805 x 1860    | 700            | TFR1350SS-49 |

The rack includes 4 steel shelves which are adjustable.





**FiFo Flow Rack accessories**

| Name   | Description  | Module | Size<br>W x D x H mm | Max<br>load kg | Code ESD       |
|--|--|--------|----------------------|----------------|----------------|
| 1 Roller top   | An extra roller top increases the space for the bins in the FiFo flow rack. Includes fixing brackets.  | M900   | 852 x 766 x 105      | 220            | TFRRT900-49    |
|  |  | M1350  | 1279 x 766 x 105     | 220            | TFRRT1350-49   |
| 2 Roller top, rear extension                             | An extra roller top of rear extension increases the space for the bins in rear extension FiFo flow rack. Includes fixing brackets.                 | M900   | 852 x 766 x 105      | 220            | TFRRT900RE-49  |
|  |  | M1350  | 1279 x 766 x 105     | 220            | TFRRT1350RE-49 |
| 3 Additional shelf for FiFo Flow Rack with steel shelves | An extra steel shelf increases the space for the bins in steel shelves version of FiFo flow rack. Includes fixing brackets.                        | M900   | 852 x 789 x 53       | 220            | TFRAS900-49    |
|  |  | M1350  | 1310 x 789 x 52      | 220            | TFRAS1350-49   |
| 4 Roller profile set, 4 pcs<br>Guide plate set, 3 pcs    | Extra roller profiles and guide plates allow you to increase storage space by using smaller bins in your FiFo flow rack.                           |        | 29 x 734 x 37        |                | TFRRS-49       |
|  |  |        | 2 x 718 x 70         |                | TFRGP-49       |
| 5 Perforated panel set, 2 pcs (left, right)              | With perforated panels you can cover both side of FiFo flow rack. With the panel hooks you can use the side panels easily as tool storage as well. |        | 15 x 736 x 812       |                | TFRPP-49       |
| 6 Castor set ESD   | Castor set for Treston FiFo Flow Rack M900 ESD   |        |                      | 300            | TFR900CS-49    |
|  | Castor set for Treston FiFo Flow Rack M1350 ESD  |        |                      | 300            | TFR1350CS-49   |

All Treston accessories available for upright tubes are suitable for FiFo Flow Rack.

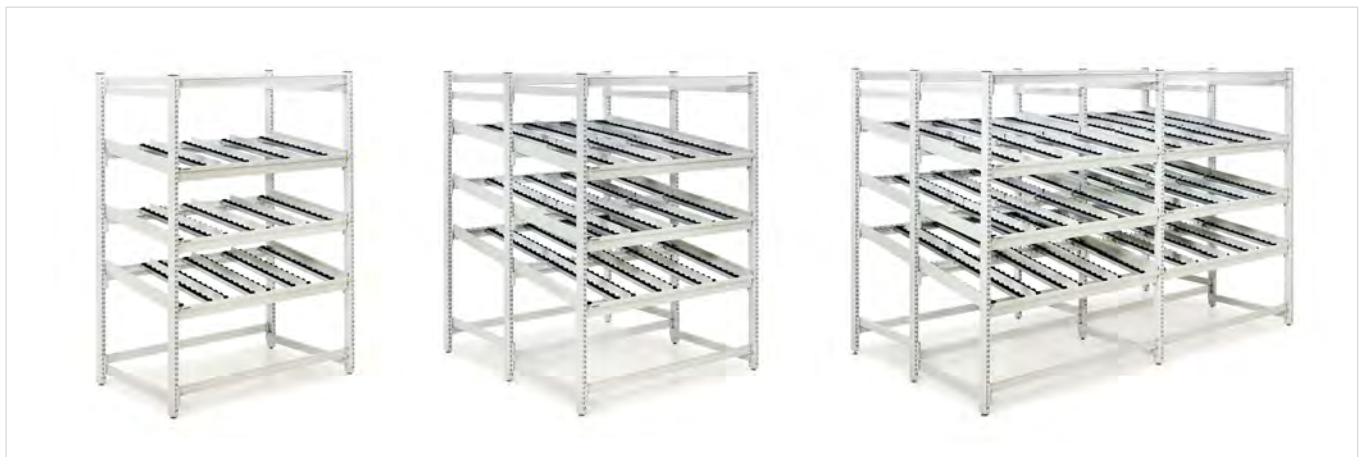

Extendable with rear and side modules – with as many modules as needed.



Watch the 2 min [animation](#) showcasing the features

# Shelving system

Shelving system can be built as a combination of cabinets and shelves and you can use it as a space divider. The storage system is available in two standard heights: 200 cm and 240 cm and two widths: 80 cm and 100 cm.

## 1. Standard parts

| Name                     | Size W x D x H mm | Code ESD      |
|--------------------------|-------------------|---------------|
| Standard part 80/30/200  | 824 x 300 x 2000  | C 313 49 001P |
| Standard part 80/40/200  | 824 x 400 x 2000  | C 314 49 001P |
| Standard part 100/30/200 | 1024 x 300 x 2000 | C 313 49 002P |
| Standard part 100/40/200 | 1024 x 400 x 2000 | C 314 49 003P |
| Standard part 100/50/200 | 1024 x 500 x 2000 | C 315 49 001P |
| Standard part 100/60/200 | 1024 x 600 x 2000 | C 316 49 001P |
| Standard part 80/40/240  | 824 x 400 x 2400  | C 314 49 002P |
| Standard part 100/40/240 | 1024 x 400 x 2400 | C 314 49 004P |
| Standard part 100/50/240 | 1024 x 500 x 2400 | C 315 49 002P |
| Standard part 100/60/240 | 1024 x 600 x 2400 | C 316 49 002P |

## 2. Extension parts

| Name                      | Size W x D x H mm | Code ESD      |
|---------------------------|-------------------|---------------|
| Extension part 80/30/200  | 804 x 300 x 2000  | C 323 49 001P |
| Extension part 80/40/200  | 804 x 400 x 2000  | C 324 49 001P |
| Extension part 100/30/200 | 1004 x 300 x 2000 | C 323 49 002P |
| Extension part 100/40/200 | 1004 x 400 x 2000 | C 324 49 003P |
| Extension part 100/50/200 | 1004 x 500 x 2000 | C 325 49 001P |
| Extension part 100/60/200 | 1004 x 600 x 2000 | C 326 49 001P |
| Extension part 80/40/240  | 804 x 400 x 2400  | C 324 49 002P |
| Extension part 100/40/240 | 1004 x 400 x 2400 | C 324 49 004P |
| Extension part 100/50/240 | 1004 x 500 x 2400 | C 325 49 002P |
| Extension part 100/60/240 | 1004 x 600 x 2400 | C 326 49 002P |

All standard and extension parts include 6 shelves.



**Load capacity** 1000 kg/part

width 824 mm

150 kg/shelf

width 1024 mm

150 kg/shelf



### The W x D x H rule

All our dimensions follow a WDH rule, where the first dimension is the width (W), the middle the depth (D), and the last the height (H).

# Industrial cabinets

## 1. 80/200 C 309 49 001

| Qty | Name                 | Size W x D x H mm | Max load kg | Code ESD     |
|-----|----------------------|-------------------|-------------|--------------|
| 1   | Cabinet frame 80/200 | 800 x 425 x 2000  | 1000        | C 309 49 000 |
| 4   | Steel shelf 80       | 730 x 396 x 32    | 100         | 854 345-49   |

## 2. 80/100 C 305 49 001

| Qty | Name                 | Size W x D x H mm | Max load kg | Code ESD     |
|-----|----------------------|-------------------|-------------|--------------|
| 1   | Cabinet frame 80/100 | 800 x 425 x 1000  | 500         | C 305 49 000 |
| 2   | Steel shelf 80       | 730 x 396 x 32    | 100         | 854 345-49   |



# Shelving cabinets

Shelving cabinets are made of epoxy powder coated steel. The frames and doors are painted with light grey RAL 7035. The cabinet has sturdy double leaf-doors, flush fitting handle with two keys. Shelving cabinet can be moved with fork lift. There are leveling screws under the cabinet for adjusting the cabinet straight. The shelving cabinets are pre-assembled.



### Move with a pallet truck

The cabinet can be moved with a pallet truck or a forklift when it is empty. Cabinets are equipped with adjustment screws.



### Shelving cabinets (includes 2 or 4 shelves)

| Name                                 | Size W x D x H mm | Max load kg | Code ESD      |
|--------------------------------------|-------------------|-------------|---------------|
| Shelving cabinet 100/40/200          | 1030 x 430 x 2010 | 600         | SC10040200-49 |
| Shelving cabinet 100/50/200          | 1030 x 530 x 2010 | 600         | SC10050200-49 |
| Shelving cabinet 100/60/200          | 1030 x 630 x 2010 | 600         | SC10060200-49 |
| Shelving cabinet 100/40/100          | 1030 x 430 x 1040 | 300         | SC10040100-49 |
| Shelving cabinet 100/40/100          | 1030 x 530 x 1040 | 300         | SC10050100-49 |
| Additional shelf                     | 1000 x 400        | 150         | 852 231-49    |
| Additional shelf                     | 1000 x 500        | 150         | 852 185-49    |
| Additional shelf                     | 1000 x 600        | 150         | 852 187-49    |
| Perforated panel 1000                | 983 x 500         |             | 852 145-49    |
| Drawer 100/100, for 400 deep cabinet | 920 x 345 x 107   | 30          | 834 513-49    |
| Drawer 100/100, for 500 deep cabinet | 920 x 345 x 107   | 30          | 834 514-49    |

### Combination name

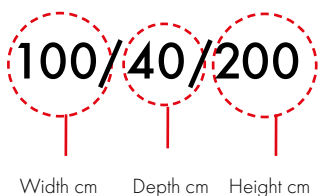

### Load capacity

150 kg/shelf



600 kg/cabinet



# Small parts storage cabinets

Our product range features four different, small parts storage cabinets for ESD-protected storage of sensitive components. The style of these storage cabinets represents the latest in industrial design. These cabinets can be wall hung, mounted on turntables, or stood on a work top. Two frames of different heights are available, 290 and 550 mm.

A storage cabinet consists of a frame, shelves, small drawers and labels. The frame is made of semiconductive polypropylene (PP), the drawers of semiconductive polystyrene (PS), and the shelves of galvanised steel. Small drawers are detailed on page 79. Cabinets come as standard with a connector for a ground-connection cord (not provided). Accessories: cross dividers made of semiconductive polystyrene (PS).



|  |                    |                    |                    |                    |
|--|--------------------|--------------------|--------------------|--------------------|
| Contains cabinets (quantity x type)                  | 24 x L-61-4ESD     | 12 x L-64-4ESD     | 48 x L-61-4ESD     | 24 x L-64-4ESD     |
| Cabinet dimensions W x D x H                         | 69 x 170 x 40 mm   | 92 x 170 x 62 mm   | 69 x 170 x 40 mm   | 92 x 170 x 62 mm   |
| Frame dimensions W x D x H                           | 310 x 180 x 290 mm | 310 x 180 x 290 mm | 310 x 180 x 550 mm | 310 x 180 x 550 mm |
| Cross dividers, ordered separately (quantity/drawer) | V-1-4ESD (5 pcs)   | V-4-4ESD (5 pcs)   | V-1-4ESD (5 pcs)   | V-4-4ESD (5 pcs)   |
| <b>Code ESD</b>                                      | 291-4ESD           | 294-4ESD           | 551-4ESD           | 554-4ESD           |

**+** **Cabinet trolley on page 68.**  
This assembly holds 8 cabinets, which must be ordered separately.





# Spacemisers for small parts storage cabinets

Thousands of sensitive components and other parts can be kept in proper order using an ESD-protected spacemiser. The assembly holds 12 storage cabinets from series 551/554 ESD (ordered separately). Owing to its robust base and divider shelf system, the spacemiser retains its cabinets firmly in place and has a load capacity of 400 kg.

Mounted on a ball-bearing base, the unit can be effortlessly rotated for ease of use. A single assembly can offer storage for up to 3456 different items on a floor area of only 0.25 sqm. Earthing via a 1 megaohm protective resistor. The unit is easy to assemble.

## Spacemiser

| Size W x D x H mm | Max load kg | Code ESD   |
|-------------------|-------------|------------|
| 500 x 500 x 1730* | 400         | 12-550 ESD |

\*The overall dimensions of a completely assembled unit.



## Bench top spacemiser PTP-5 ESD

This unit holds two small parts storage cabinets, 290 mm or 550 mm in height, with their backs facing each other – cabinets must be ordered separately. The assembly comprises a ball-bearing base and a bottom plate. Includes a ground-connection cord.

## Bench top spacemiser

| Size W x D x H mm*               | Max load kg | Code ESD  |
|----------------------------------|-------------|-----------|
| 360 x 310 x 300 mm (series 290)* | 50          | PTP-5 ESD |
| 360 x 310 x 560 mm (series 550)* |             |           |

\*The overall dimensions of a completely assembled unit.



ESD bench top spacemiser



# Storage bin cabinets

Designed for the electronics industry. These cabinets can be wall hung or mounted on turntables, or stood on a work top. This product is available in two depths, 300 and 400 mm.

This product includes a frame, bins and labels with protective shields. The steel frame has a semiconductive ESD powder-coat finish in grey, the bins are of semiconductive polypropylene (PP). Backstops hold the bins when fully extended. Details on the shelf bins can be found on page 80. Cabinets come with a connector for a ground-connection cord as standard. Accessories: cross dividers made of semiconductive polypropylene (PP).



|  |                    |                    |                    |                    |
|--|--------------------|--------------------|--------------------|--------------------|
| Contains bins (quantity x type)                      | 8 x 3020-4ESD      | 16 x 3010-4ESD     | 8 x 4020-4ESD      | 16 x 4010-4ESD     |
| Bin dimensions W x D x H                             | 186 x 300 x 82 mm  | 92 x 300 x 82 mm   | 186 x 400 x 82 mm  | 92 x 400 x 82 mm   |
| Frame dimensions W x D x H                           | 400 x 300 x 395 mm | 400 x 300 x 395 mm | 400 x 400 x 395 mm | 400 x 400 x 395 mm |
| Cross dividers, ordered separately (quantity/drawer) | D-20-4ESD (4 pcs)  | D-10-4ESD (4 pcs)  | D-20-4ESD (6 pcs)  | D-10-4ESD (6 pcs)  |
| <b>Code ESD</b>                                      | 0830 ESD           | 1630 ESD           | 0840 ESD           | 1640 ESD           |

# Spacemisers for storage bin cabinets

A free-standing spacemiser storage system for the electronics industry. The robust, ball-bearing base has a load capacity of 800 kg. These assemblies offer storage for up to 1792 different items on a floor area of only 0.64sqm. The unit includes a ball-bearing base and shelves in 4 layers. Earthing via a 1 megaohm protective resistor. Easy to assemble – no tools required.

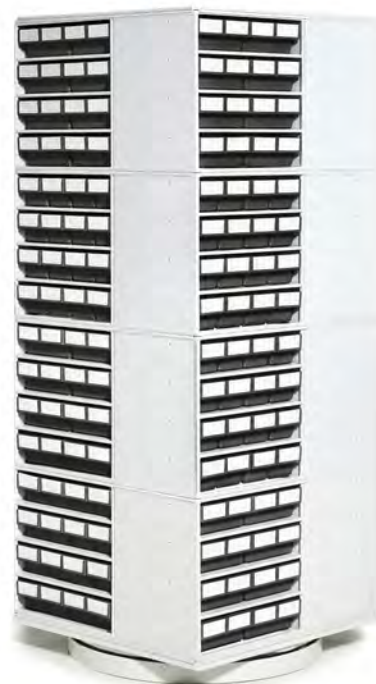

## Spacemiser

| Name         | Size W x D mm    | Max load kg | Code ESD   |
|--------------|------------------|-------------|------------|
| Spacemiser*  | 700 x 700 x 1680 | 800         | 16-300 ESD |
| Spacemiser** | 800 x 800 x 1680 | 800         | 16-400 ESD |

\*This unit holds 16 storage bin cabinets from series 0830/1630 ESD (ordered separately).

\*\*This unit holds 16 storage bin cabinets from series 0840/1640 ESD (ordered separately).

# High density storage cabinets

High density storage cabinets provide a lot of ESD-protected storage in a very small foot print. These cabinets can be equipped with castors when necessary.

This product includes a frame, bins and labels with protective shields. The steel frame has a semiconductive ESD powder-coat finish in light grey (RAL 7035). The shelves are made of galvanised steel and the bins of semiconductive polypropylene (PP). Backstops hold the bins when fully extended. Adjustable feet are provided for fine levelling of the cabinet on uneven surfaces. The load capacity of a cabinet is 240 kg and a single shelf is 30 kg. Earthing via a 1 megaohm protective resistor. Bin dimensions can be found on page 80. Accessories: cross dividers and a castor set.



2440 ESD

4840 ESD

## High density storage cabinets

|   | Code ESD             | Code ESD             |
|---|----------------------|----------------------|
|   | 2440 ESD             | 4840 ESD             |
| Includes drawers<br>(type/quantity)                     | 4020<br>(24 pcs)     | 4010<br>(48 pcs)     |
| Frame depth   | 410                  | 410                  |
| width   | 605                  | 605                  |
| height  | 870                  | 870                  |
| Cross dividers, ordered<br>separately (quantity/drawer) | D-20-4ESD<br>(6 pcs) | D-10-4ESD<br>(6 pcs) |

## Castor set

| Name              | Size mm | Max load kg | Code ESD  |
|-------------------|---------|-------------|-----------|
| Castor set, 4 pcs | Ø 100   | 150         | PS-LH ESD |



2440 ESD + PS-LH ESD

# ESD bins

## 1. Shelf bins

| External dimensions<br>W x D x H mm | Capacity,<br>litres | Quantity,<br>package | Cross divider<br>(ordered separately) | Code ESD  |
|-------------------------------------|---------------------|----------------------|---------------------------------------|-----------|
| 92 x 300 x 82                       | 1,3                 | 30                   | D-10-4ESD                             | 3010-4ESD |
| 92 x 400 x 82                       | 1,9                 | 30                   | D-10-4ESD                             | 4010-4ESD |
| 92 x 500 x 82                       | 2,4                 | 30                   | D-10-4ESD                             | 5010-4ESD |
| 132 x 400 x 100                     | 3,2                 | 20                   | D-15-4ESD                             | 4015-4ESD |
| 132 x 500 x 100                     | 4,5                 | 20                   | D-15-4ESD                             | 5015-4ESD |
| 132 x 600 x 100                     | 5,5                 | 15                   | D-15-4ESD                             | 6015-4ESD |
| 186 x 300 x 82                      | 3,0                 | 15                   | D-20-4ESD                             | 3020-4ESD |
| 186 x 400 x 82                      | 4,2                 | 15                   | D-20-4ESD                             | 4020-4ESD |
| 186 x 500 x 82                      | 5,3                 | 15                   | D-20-4ESD                             | 5020-4ESD |
| 186 x 600 x 82                      | 6,5                 | 15                   | D-20-4ESD                             | 6020-4ESD |

Made of semiconductive polypropylene (PP). A full-width label with a protective shield is easy to keep clean and change when necessary – such shields and labels are not conductive.

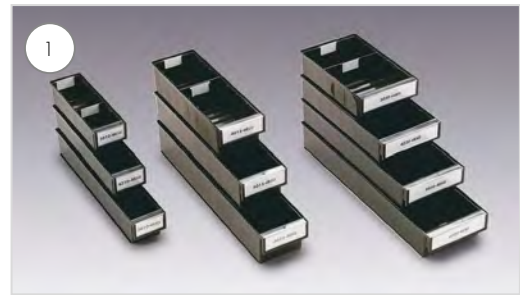

## 2. Small drawers

| External dimensions<br>W x D x H mm | Capacity,<br>litres | Quantity,<br>package | Cross divider<br>(ordered separately) | Code ESD  |
|-------------------------------------|---------------------|----------------------|---------------------------------------|-----------|
| 69 x 170 x 40                       | 0.2                 | 96                   | V-1-4ESD                              | L-61-4ESD |
| 92 x 170 x 62                       | 0.7                 | 45                   | V-4-4ESD                              | L-64-4ESD |

Made of semiconductive polystyrene (PS). A spare part for small parts storage cabinets; see page 76.

## 3. Picking bins

| External dimensions<br>W x D x H mm | Capacity,<br>litres | Quantity,<br>package | Includes         | Code ESD    |
|-------------------------------------|---------------------|----------------------|------------------|-------------|
| 99 x 160 x 70                       | 1.1                 | 60                   |                  | 30-1L-4ESD  |
| 198 x 160 x 70                      | 2.2                 | 30                   |                  | 30-2L-4ESD  |
| 198 x 160 x 70                      | 2.2                 | 30                   | 2 fixed dividers | 30-23L-4ESD |

Ideal for highly repetitive picking tasks such as typesetting. Made of semiconductive polystyrene (PS).



## 4. Storage bins

| External dimensions<br>W x D x H mm | Capacity,<br>litres | Quantity, package | Code ESD  |
|-------------------------------------|---------------------|-------------------|-----------|
| 185 x 490 x 250                     | 12.0                | 12                | 1949-4ESD |
| 310 x 490 x 250                     | 22.0                | 12                | 3149-4ESD |

Made to order. Request a quotation.

Ideal for in-house material flows within factories and warehouses. Semiconductive polypropylene (PP).



## 5. Stacking bins

| External dimensions<br>W x D x H mm | Capacity,<br>litres | Quantity,<br>package | Cross divider<br>(ordered separately) | Labels + shields<br>(ordered separately) | Code ESD   |
|-------------------------------------|---------------------|----------------------|---------------------------------------|--|------------|
| 105 x 165 x 75                      | 0.6                 | 60                   | –                                     | E-10                                     | 1015-4ESD  |
| 149 x 192 x 105                     | 1.5                 | 45                   | –                                     | E-15                                     | 1520-4ESD  |
| 149 x 250 x 130                     | 2.7                 | 30                   | V-14                                  | E-15                                     | 1525-4ESD  |
| 186 x 300 x 156                     | 5.0                 | 24                   | V-19                                  | E-20                                     | 1930-4ESD  |
| 186 x 400 x 156                     | 7.2                 | 24                   | V-19                                  | E-20                                     | 1940-4ESD  |
| 186 x 510 x 182                     | 9.6                 | 12                   | V-195                                 | E-20                                     | 1950-4ESD* |
| 310 x 400 x 156                     | 11.9                | 12                   | V-30                                  | E-20                                     | 3040-4ESD* |
| 310 x 500 x 182                     | 17.8                | 8                    | V-30                                  | E-20                                     | 3050-4ESD* |

\*Made to order. Request a quotation.

Made of semiconductive polypropylene (PP). Dividers coated with a semiconductive ESD paint and labels with protective covers as an accessory. Labels and protective covers are not conductive.

### Semiconductive polystyrene = PS

- surface resistance 103...106 Ω
- volume resistivity 103...106 Ω
- temperature tolerance -40...+ 55°C

### Semiconductive polypropylene = PP

- surface resistance 103...106 Ω
- volume resistivity 103...106 Ω
- temperature tolerance -20...+ 70°C

**Arm adapters for MH/MA/MA2/MA3**

| Profile type     | Workbench model           | MH  | MA  | MA2 | MA4  |
|------------------|---------------------------|-----|-----|-----|------|
| C-profiles       | TPH                       | AS2 | AS2 | AS2 | AS4C |
| Upright profiles | Concept, QuatreX, TP, TED | AS2 | AS2 | AS2 | AS4  |

**Arm adapters for Concept, QuatreX, TED, Quick Edge and TP accessories with arms**

| Profile type           | Workbench / trolley model | 40 mm arm   | 60 mm arm   |
|------------------------|---------------------------|-------------|-------------|
| C-profiles             | TPH                       | -           | E824 081-49 |
| AL2X aluminum profiles | WB, QuatreX               | 890 524-49  | 890 525-49  |
| Aluminum profiles      | WTR                       | E821 573-49 | E821 572-49 |

**Drawer unit spare parts**

| Name                             | Size W x D x H | Compatibility        | Code ESD    |
|----------------------------------|----------------|----------------------|-------------|
| Cover with an ESD mat, assembled | 450 x 518 x 14 | 45 drawer unit       | W872 107-49 |
| Cover without mat                | 450 x 518 x 14 | 45 drawer unit       | 872 107-49  |
| ESD mat, light grey              | 445 x 513      | 45 drawer unit cover | 836 750-00  |
| Shelf for cabinet version        |                | 45 drawer unit       | 872 043-49  |
| Bracket pair for the shelf       |                | 45 drawer units      | 872 045-51  |
| Castor set Ø 100 ESD             |                | 45 drawer units      | 852 774-00  |

**Drawer interior spare parts for drawer unit 45**

| Name   | Compatibility             | Code ESD   |
|--|---------------------------|------------|
| Vertical divider                                       | 45/100 drawer             | 872 300-49 |
| Vertical divider                                       | 45/150 and 45/200 drawers | 872 301-49 |
| Divider plate L=125                                    | 45/100 drawer             | 872 302-49 |
| Divider plate L=185                                    | 45/100 drawer             | 872 303-49 |
| Divider plate L=250                                    | 45/100 drawer             | 872 304-49 |
| Divider plate L=375                                    | 45/100 drawer             | 872 305-49 |
| Divider plate L=125                                    | 45/150 and 45/200 drawers | 872 306-49 |
| Divider plate L=185                                    | 45/150 and 45/200 drawers | 872 307-49 |
| Divider plate L=250                                    | 45/150 and 45/200 drawers | 872 308-49 |
| Divider plate L=375                                    | 45/150 and 45/200 drawers | 872 309-49 |
| Divider holder set for drawer interiors (incl. 12 pcs) |                           | 853 003-00 |

**Castors**

| Name                          | Compatibility                        | Screw | Code ESD   |
|-------------------------------|--------------------------------------|-------|------------|
| Castor set Ø 100 ESD          | 45 drawer units, Storage trolley     | M10   | 852 774-00 |
| Castor set Ø 100 ESD          | Concept and TP benches               | M12   | 860 429-00 |
| Castor set Ø 100 ESD          | WB bench, QuatreX bench, TED desk    |       | LCS100 ESD |
| Castor set Ø 125 ESD          | TRTA trolley                         |       | LCS125 ESD |
| Swivel castor Ø125 ESD, brake | Treston Industrial Multi trolley ESD | M10   | 10022-00   |
| Swivel castor Ø125 ESD        | Treston Industrial Multi trolley ESD | M10   | 10020-00   |
| Castor set Ø 50 ESD           | Transport skate ESD                  | M10   | 853 175-00 |

**Spare parts labels for ESD plastic bins, dividers and small drawers**

| Name                    | Size W x H mm | Min. order quantity | Compatibility                              | Code |
|-------------------------|---------------|---------------------|--|------|
| Label for bin           | 82 x 41       | 15 pcs              | 3010-4ESD, 4010-4ESD, 5010-4ESD            | 1868 |
| Label for bin           | 12 x 41       | 15 pcs              | 4015-4ESD, 5015-4ESD, .6015-4ESD           | 3532 |
| Label for bin           | 176 x 41      | 15 pcs              | 3020-4ESD, 4020-4ESD, 5020-4ESD, 6020-4ESD | 1123 |
| Label for bin           | 77 x 26       | 12 pcs              | 1949-4ESD, 3149-4ESD                       | 1789 |
| Label for cross divider | 59 x 30       | 20 pcs              | D-10-4ESD, D-15-4ESD, D-20-4ESD            | 1792 |
| Label for small drawer  | 42 x 15,5     | 95/ A4              | 30-1L-4ESD, 30-2L-4ESD, 30-23L-4ESD        | 3195 |
| Label for small drawer  | 65,5 x 17     | 12 pcs              | L-61-4ESD                                  | 1119 |
| Label for small drawer  | 86,5 x 25     | 12 pcs              | L-64-4ESD                                  | 1120 |

# Download **free eBooks or a White paper**



## 6-point checklist for creating and maintaining ESD-protected areas

This informational e-book lists 6 steps for setting up an ESD-protected area in your workplace. No matter whether you need just one workbench or a full-scale production line, the same principles apply to ensuring that ESD protection functions as it should.



## White Paper: Comprehensive Guide on How to Measure ESD

This comprehensive guide covers everything from the ESD measuring equipment to methods for measuring in your workspace. We'll walk you through the ESD standards and provide practical guides of how the measuring works in industrial workstations.

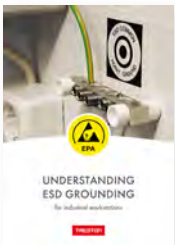

## White Paper: Understanding ESD grounding for industrial workstations

Grounding is the foundational principle in ESD control. It involves creating a direct path for static charges to dissipate into the earth. Effective grounding reduces the risk of electrostatic discharge, protecting sensitive electronic components during handling and assembly.

These and more educative and useful e-books available on our website:

[treston.com/catalogues-and-brochures](https://treston.com/catalogues-and-brochures)



## Product animations, informational videos and more!

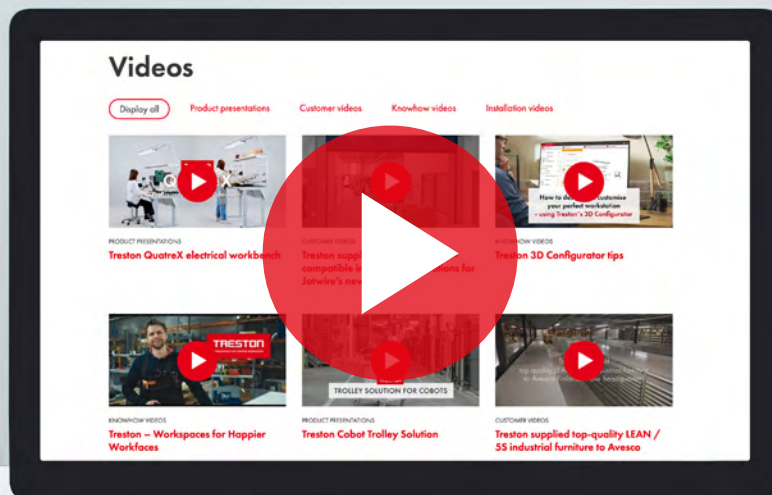

[treston.com/videos](https://treston.com/videos)



# What our customers say



**"Several competitor products we viewed didn't give us the same level of confidence, modularity and robustness"**

– David Walch, Operations Director,  
FT Technologies

**STIEBEL ELTRON**

**"At Treston, we have found the solution with ESD-compliant and electrically height-adjustable tables."**

– Jan Müller, Production Planner,  
Stiebel Eltron

**bol.com**

**"The two most important goals were ergonomics and efficiency. This we have reached by using Treston."**

– Lisanne Broer-van Abeelen,  
bol.com fulfilment center



**"Thank you for the informative day at Treston. Your great team impressed me with their knowledge."**

– M. Huber, Kaiserslautern,  
SKS Welding Systems GmbH



**"The new furniture has significantly improved ergonomics, occupational health, and job satisfaction."**

– Hannu Pesonen,  
Development Manager, Jotwire

**Read all our customer stories at:**

[treston.com/about-us/  
customer-stories](https://treston.com/about-us/customer-stories)



## HEADQUARTERS

Treston Oy  
Sorakatu 1  
FI-20730 Turku  
Tel. +358 10 4469 11  
sales@treston.com  
www.treston.com

## FACTORIES

Treston Oy, Turku plant  
Sorakatu 1  
FI-20730 Turku  
Tel. +358 10 4469 11  
sales@treston.com  
www.treston.fi

Treston Oy, Jyväskylä plant  
PO Box 33 (Sohlberginkatu 10)  
FI-40351 Jyväskylä  
Tel. +358 10 4469 11  
sales@treston.com  
www.treston.fi

## FRANCE

Treston France SARL  
Z.A.C. de la Bonne Rencontre  
1, voie Gallo Romaine, Quincy-Voisins  
77334 Meaux Cedex  
Tel. +33 1 64 17 11 11  
infofr@treston.com  
www.treston.fr

## GERMANY

Treston Deutschland GmbH  
Friedrich-Ebert-Damm 143  
22047 Hamburg  
Tel. +49 40 8816 5022 - 0  
info.de@treston.com  
www.treston.de

Treston Deutschland GmbH  
Niederlassung Raunheim  
Frankfurter Straße 101  
65479 Raunheim  
Tel. +49 6142 992 50  
mail.de@treston.com  
www.treston.de

## SWEDEN

Treston AB  
Polygonvägen 73  
187 66 Täby  
Tel. +46 8 511 791 60  
info.se@treston.com  
www.treston.se

## UNITED KINGDOM

Treston Ltd  
Treston House  
5b Bone Lane, Newbury  
Berkshire, RG14 5SH  
Tel. +44 1635 521521  
salesuk@treston.com  
www.treston.com

## USA

Treston, Inc.  
156 Bluffs Court  
Canton, GA 30114  
Tel. +1 770-721-7980  
infousa@treston.com  
www.treston.us

## PREMIUM PARTNERS:

## BENELUX

Human Workspace BV  
Mechelaarstraat 17  
4903 RE Oosterhout  
Tel. +31 162 454 383  
sales@humanworkspace.nl  
www.humanworkspace.nl

## NORWAY

Industrimøbler AS  
Bjørnerudveien 12A  
1266 Oslo  
Tel. +47 22 25 05 00  
post@industrimobler.no  
www.industrimobler.no



Thanks to our global sales network, you can receive local support and customer service anywhere in the world.

Find your nearest retailer: [www.treston.com/contact-us](http://www.treston.com/contact-us)



[www.linkhamson.com](http://www.linkhamson.com)  
[sales@linkhamson.com](mailto:sales@linkhamson.com)  
01494 439786

# TRESTON

## Workspaces for happier workfaces.

This is our aspiration. This is our promise. This is what Treston is all about.

With decades of experience, in-depth understanding of ergonomics in industrial environments, unmatched ESD competence and proven LEAN knowhow we at Treston are in a unique position to help our customers in keeping their business and people in good shape.

[treston.com](http://treston.com)



[www.linkhamson.com](http://www.linkhamson.com)  
[sales@linkhamson.com](mailto:sales@linkhamson.com)  
01494 439786