

INSPECTIS[®] Software for Image Capture, Analysis, Metrology and Reporting

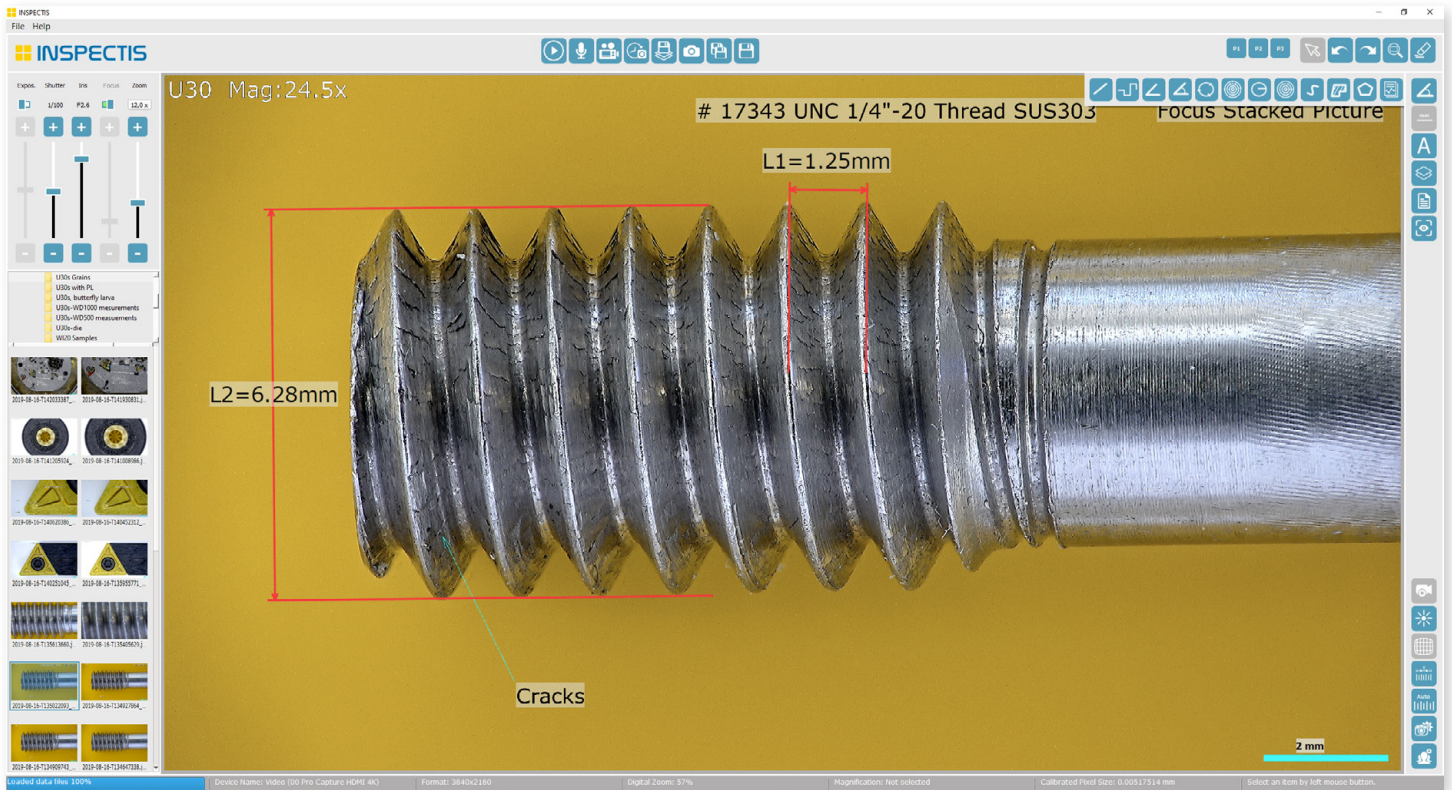

Designed for Productivity

Empowering Inspectis Digital Microscopes

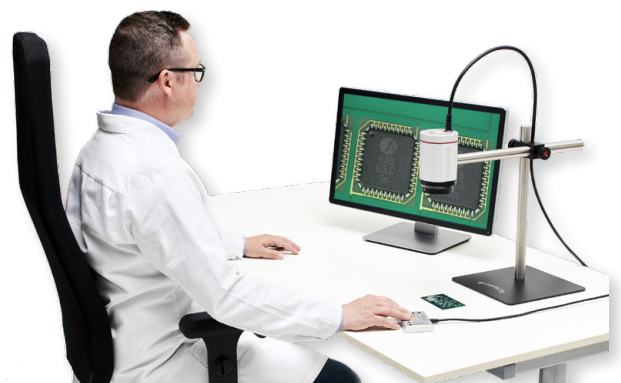
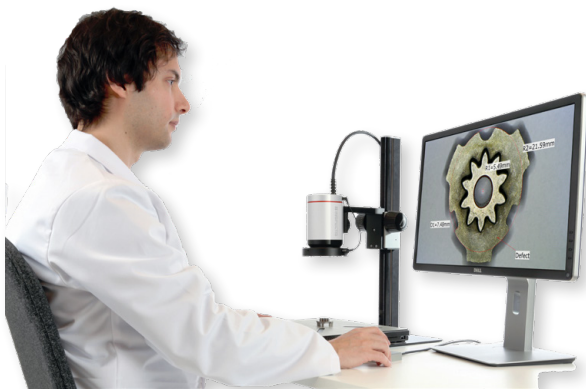

“Reduce the time spent on Inspection, Analysis and Measurements”

Designed for Productivity

Powerful yet easy-to-use live image view, capture, utility and metrology software, specially designed for full range of Inspectis HD, Full HD, 4K and USB3.0 digital microscopes.

INSPECTIS® software provides powerful tools for calibration of device magnification, live image overlays and comparison, focus stacking, annotations and reporting.

Available in 4 functionality levels, Basics, Pro, ProX and Overlay.

Icon-based User Interface

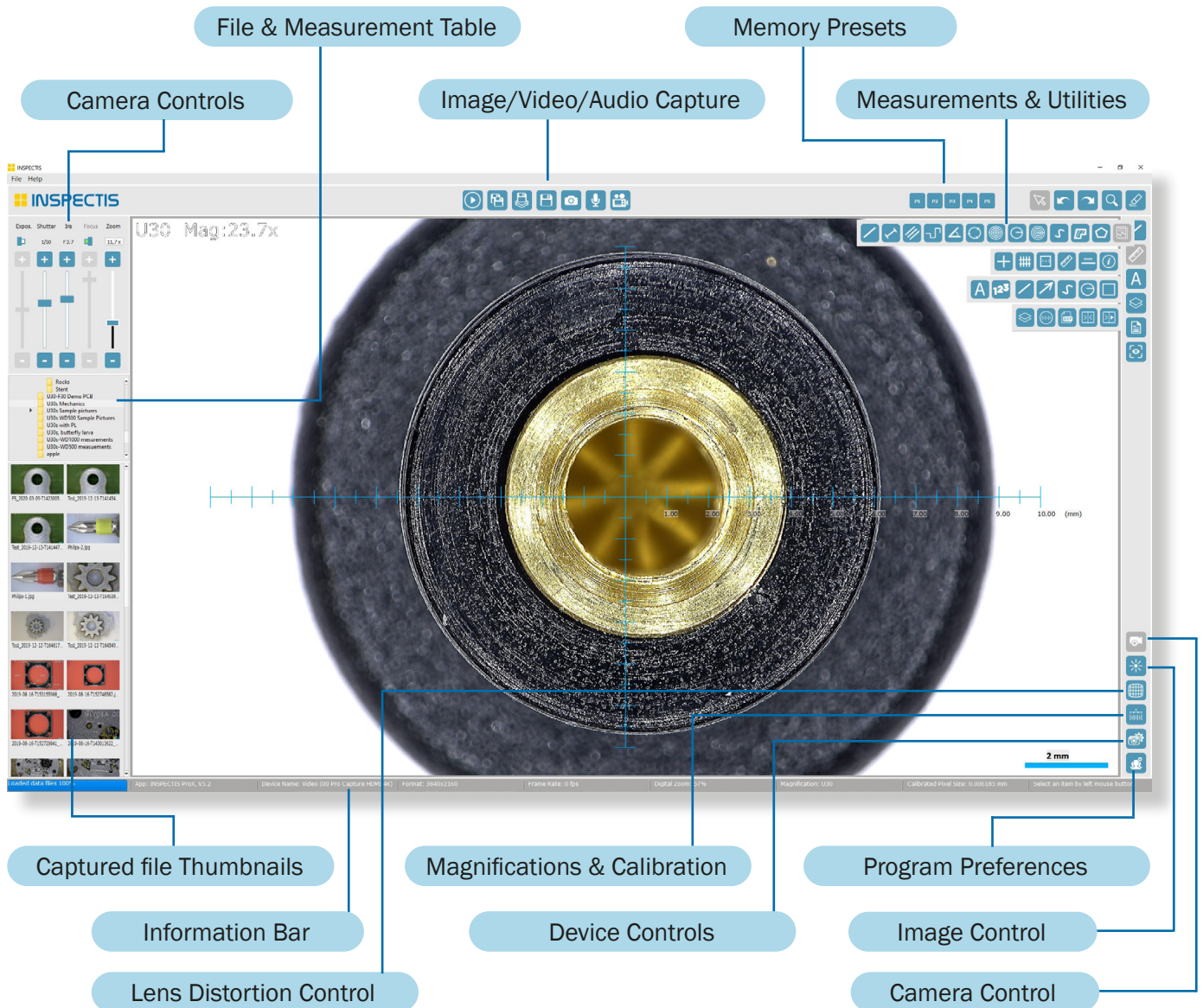

Thanks to its powerful video processing engine, user-friendly interface and streamlined workflow, INSPECTIS software reduces time spent on capture, analysis, measurements and documentation of your inspection objects.

Results can be exported or printed as certificates and reports with custom made templates.

Available in 4 functionality levels, **Basics, Pro, ProX and Overlay**

Effortless Navigation and Operation

INSPECTIS® software is designed to help users navigate effortlessly. With a logical layout and graphical icons for each function, operators can quickly become familiar with the INSPECTIS software, saving time during measurement routines and reducing the need for training sessions.

Icon-based Function Tools

Measurement tools



Distance, Poly-line, Angle, Circle, Concentric Circles, Free-form curve, Area and Polygon measurements

Crosshair, Grid & Graticule



Crosshair, Grid, Rectangle, 2D Ruler, and Reference Scale overlay on live image

Compare & Image Overlay



Edge Detection and DXF Editor

Interval Overlay live image, DXF Cad file, Digital Graticule, Compare, Compare Live, Interval Compare

Auto/Manual Calibration



Auto Distortion Compensation

Automatic Calibration of Magnifications. Automatic Lens Distortion Compensation

Annotation & Count



Drawing

Annotations and Object Count

Interval Overlay with Timer



Graticule overlay, Semitransparent overlay, Interval overlay of live image on reference picture with time adjustment

Auto & Manual Focus Stacking

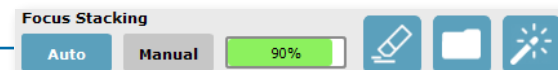

Automatic Focus Stacking, Manual Focus Stacking, Clear Images, Load External Images, Enhanced Focus Stacking Filter

Memory Presets



1 to 5 Camera and Lens Configurations can be saved in memory for quick recall through P1 to P5 Icons on software

Please check software version for feature availability.



INSPECTIS[©] Basics

Highly simplified image view, capture and distance measurement software. Tools such as direct camera control, automatic distortion control, digital zoom, overlay grids, rectangle and crosshair, annotation on image and contrast enhancement are available.

An easy to use yet powerful software when camera control and digital image acquisition are primary requirements.

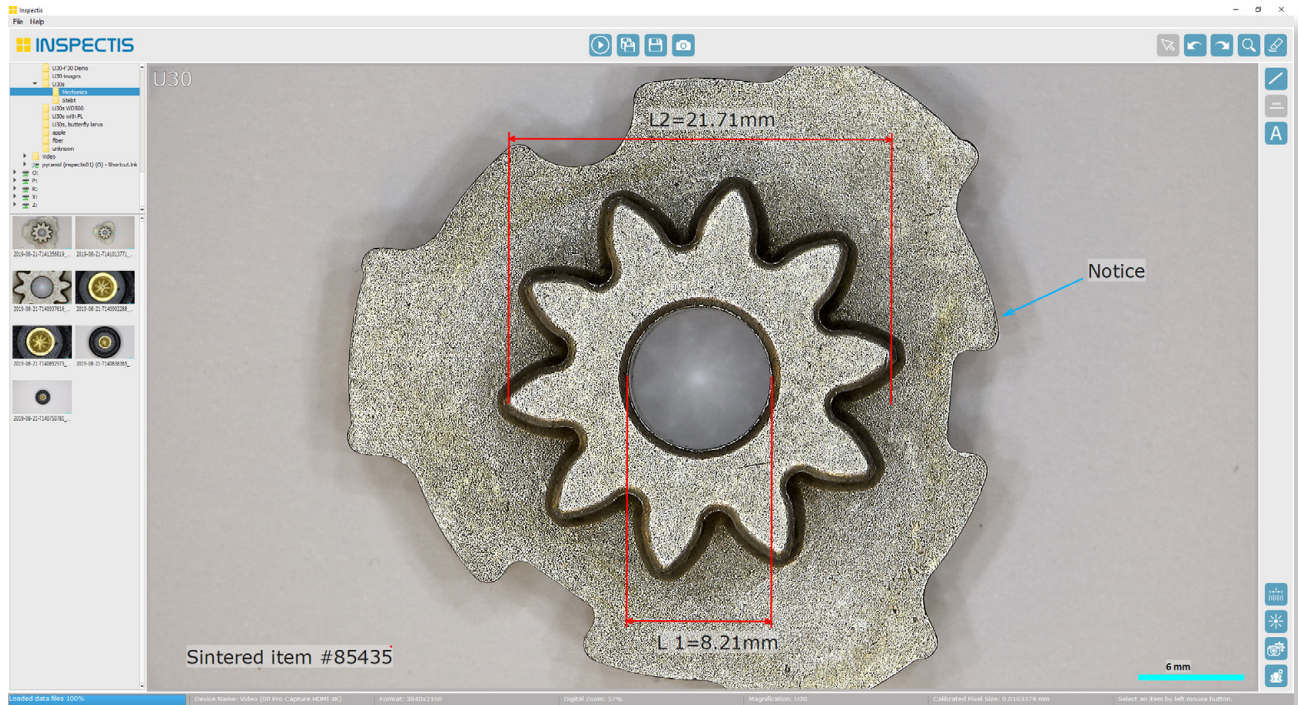

An easy-to-use digital documentation solution!



INSPECTIS[©] Basics Highlights

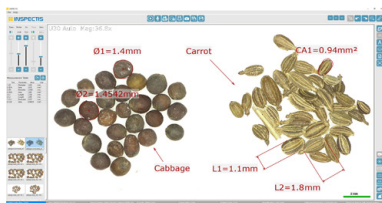

Grains, x12 Zoom with +5 macro



Micro mechanics, x9 Zoom



Electronics PCB, x30 Zoom, +10

- Direct Inspectis camera and lens parameters control
- Easy image view and capture
- Digital zoom, pan and flip of still and live image
- Define and calibrate magnifications
- On-screen distance measurement
- Annotations and feature markup tools
- Write comments and link to each picture
- Crosshair, grid and rectangle overlay on live image
- Change font, size and colour
- Count objects on image
- Store images as jpg and png files
- Adjust device properties and device resolution
- Metric and imperial units
- Multilanguage interface
- Software compatible with other microscope cameras

INSPECTIS[©] Pro

Powerful image view, capture and metrology software. A wide range of utility functions such as direct camera control, lens distortion correction, memory presets along with comprehensive measurement tools and image compare functions are available.

An easy to use yet powerful software when metrology, image acquisition, optical inspection, qualification and reporting are primary requirements.

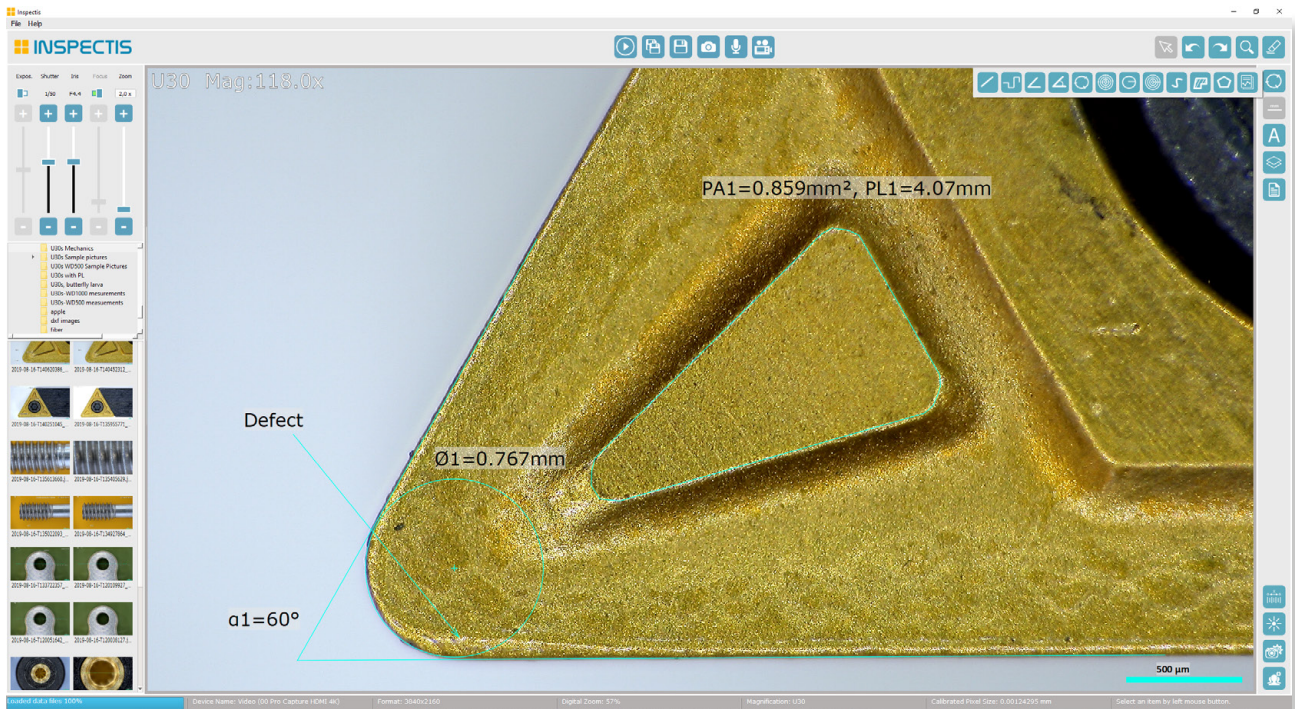

A complete measurement and documentation solution!



INSPECTIS[©] Pro Highlights

In addition to Basics:

- Powerful set of geometry measurement tools
- Snap function for easy selection of geometry points
- Automatic lens distortion correction
- Automatic calibration tracking for all zoom positions
- Auto-creation of measurement table for data reporting
- Export measurements data to Excel file
- Compare live to still or still to still images
- Overlay 2-dimensional mm/ μm scales on live image
- Overlay semi-transparent picture on live image
- Record video and audio
- Auto-creation of reports and certificates
- 5 memory presets and recall for camera parameters
- Password option for camera parameters control

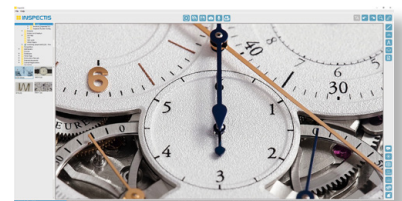

Micro mechanics, x7.6 Zoom

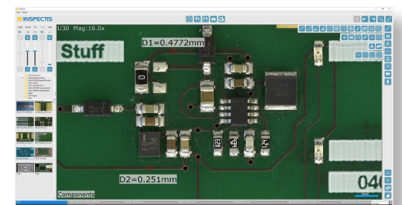

Electronics PCB, x10 Zoom

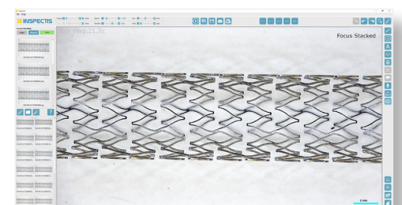

Medtech, x12 Zoom

INSPECTIS[©] ProX

Advanced metrology, analysis and utility software with real-time communication with digital cameras.

Besides metrology, analysis and documentation features, ProX provides powerful tools, automatic focus stacking and memory presets.

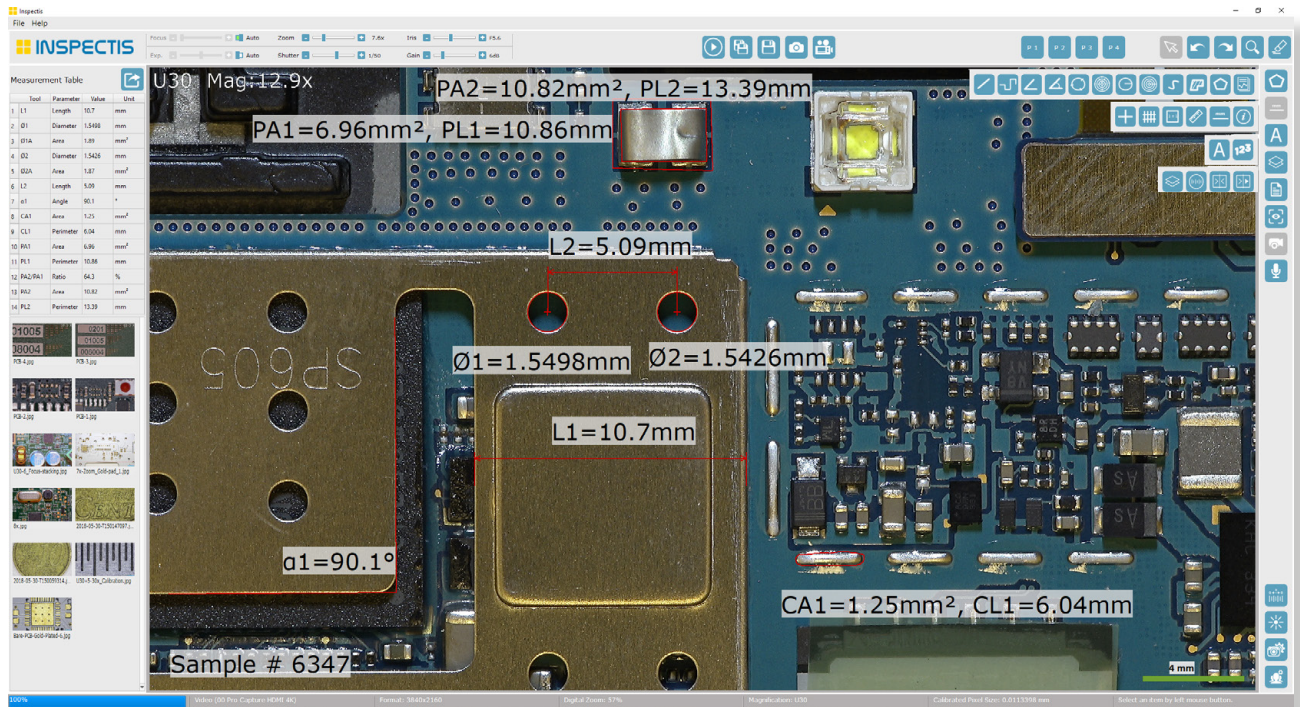

When full functionality is required!



INSPECTIS[©] ProX Highlights

In addition to Pro:

- Automatic focus stacking (Field of view extender)
- Manual focus stacking
- Time lapse video recording
- Time interval Overlay Assisted Inspection (OAI)
- Optical edge detection and DXF export
- DXF new, import, edit and export
- Drawing toolbox for DXF edit
- DXF overlay on live image
- DXF export as PNG file
- PNG overlay on live image as digital graticule
- Automatic alignment of overlaid image to live image
- Automatic rescaling of overlaid image through zoom

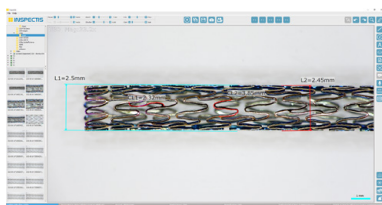

Medtech, x21 Zoom

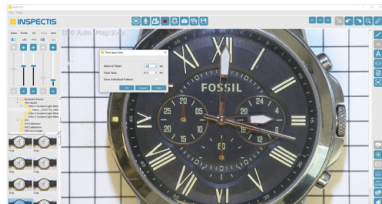

Time lapse, x5 Zoom



Electronics, x22.3 Zoom +10

Advanced Features INSPECTIS[®] Pro, ProX and Overlay

Several advanced features are available in INSPECTIS[®] Pro, ProX and Overlay among them:

Focus Stacking

Create images with extended depth of focus by taking 10-25 images at different focus depths to create one ultra-sharp image. (available in ProX).

Automatic Focus Stack

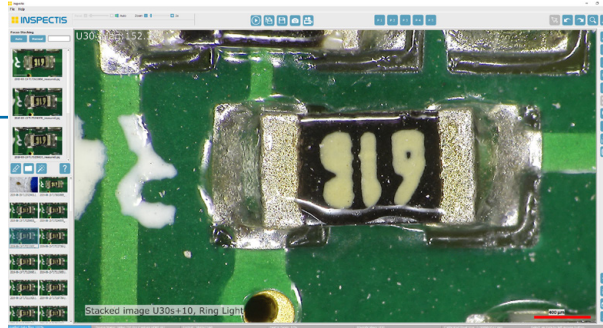

Compare Windows

Compare live image to a reference picture or compare 2-4 still images to each other. (available in Pro, ProX and Overlay).

Compare Window

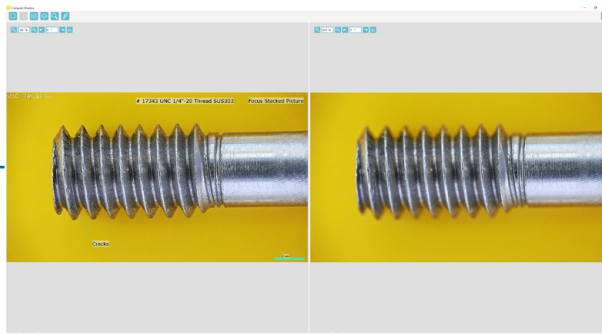

Overlay Assisted Inspection

Overlay of live image on a reference picture with timer controlled interval display. An efficient tool for identifying missing components, wrong polarity, misplacements and other defects on assembled PCBs. (available in ProX and Overlay).

Overlay Assisted Inspection

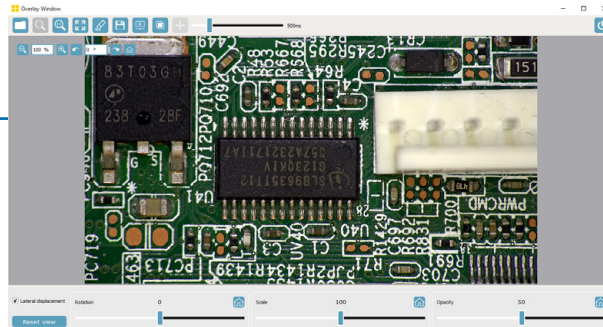

DXF editor and Overlay

Create a DXF file from your object by optical edge detection. Open an existing DXF CAD file, edit, draw patterns, shapes, add text and overlay on live image. Save in DXF or PNG format and display as Digital Graticule on live image! (available in ProX and Overlay).

DXF Editor and Overlay

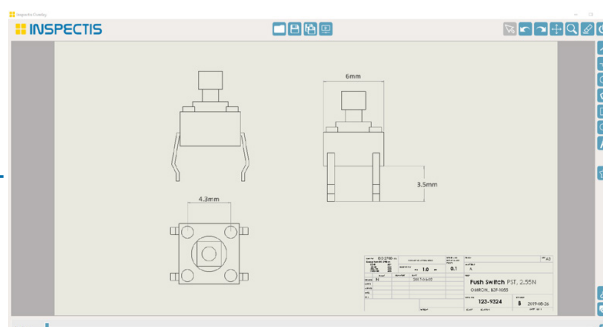

Data Export and Reporting in **Pro, ProX**

Measurement Data:

Data table is generated automatically and linked to the measured image.

Measurement Data Table

Measurement Table				
	Tool	Parameter	Value	Unit
1	L1	Length	10.7	mm
2	Ø1	Diameter	1.5498	mm
3	Ø1A	Area	1.89	mm ²
4	Ø2	Diameter	1.5426	mm
5	Ø2A	Area	1.87	mm ²
6	L2	Length	5.09	mm
7	α1	Angle	90.1	°
8	CA1	Area	1.25	mm ²
9	CL1	Perimeter	6.04	mm
10	PA1	Area	6.96	mm ²
11	PL1	Perimeter	10.86	mm
12	PA2/PA1	Ratio	64.3	%
13	PA2	Area	10.82	mm ²

Data Export



Reporting:

Report and certificate generator with user-defined templates. Measurement data and comments are automatically imported with selected images.

Customised Templates

Cover Summary Page

Report Pages with Data





INSPECTION OF SINTERED TOOL
Sample Lot 23455

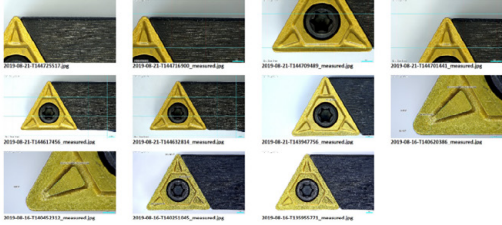

INSPECTIS AB
Gerfågistarevägen 5
SE-171 48, Solna
Sweden

ID: Lot 23455
Date: 2019-08-21
Name: Mark Bergkvist
Notes: Quality of edge of samples are tested at different magnification.

Test equipment:
U30s Advance Kit



Signature
Mark Bergkvist



Comparison table **Basics, Pro, ProX, Overlay**

Feature	Basics	Pro *	ProX*	OAI*
Live image view, freeze to still image	•	•	•	•
Digital zoom of still and live image	•	•	•	•
Full screen image view	•	•	•	•
Define resolution of captured video	•	•	•	•
Define and calibrate custom magnifications	•	•	•	•
Import and calibrate external images	•	•	•	•
Memory pre-sets and recall for camera and lens configurations (5 pcs)	• *	•	•	•
Direct camera and lens parameters controls	• *	•	•	•
Automatic calibration of entire zoom range of the camera	• *	•	•	•
Automatic calibration tracking for all camera zoom positions	• *	•	•	•
Automatic lens distortion correction in live image	• *	•	•	•
Flip image vertically/horizontally, b/w conversion and enhanced contrast	•	•	•	•
Distance measurement	•	•	•	•
Annotations on Image	•	•	•	•
Objects count on image	•	•	•	•
Select, move, adjust, erase, undo/redo measurements and annotations	•	•	•	•
Overlay grids, rectangle and crosshair on live image	•	•	•	•
File folder system management	•	•	•	•
Open/save images with calibration	•	•	•	•
Save multiple frames to one picture	•	•	•	•
Add comments to saved images	•	•	•	•
Print images	•	•	•	•
Send files by email	•	•	•	•
Multilanguage interface	•	•	•	•
Password option for camera and lens parameters control		•	•	•
Calibration tracking error compensation		•	•	•
Record video and audio		•	•	
Free-form area, length and perimeter measurements		•	•	
Circle, angle, curve length and polygon measurements		•	•	
Auto snap to measurement lines, ends, corners and centers		•	•	
Export performed measurements (TXT and EXCEL)		•	•	
Generate reports and certificates with images and measurements		•	•	
Overlay 2-dimensional mm/μm scales on live image		•	•	•
Overlay semi-transparent picture on live image		•	•	•
Compare live to still or still to still images		•	•	•
Time lapse video capture and recording			•	•
Automatic and manual focus stacking (dept of field extender)			•	
Time interval Overlay Assisted Inspection (OAI)			•	•
Optical edge detection and DXF export			•	•
DXF new, import, edit and export			•	•
Drawing toolbox for DXF			•	•
PNG export of DXF files			•	•
DXF overlay on live image			•	•
PNG overlay on live image as digital graticule			•	•
Automatic alignment of overlaid image to live image			•	•
Automatic rescaling of overlaid image through lens zoom			•	•

* USB communication cable (item HD-035) is always included in INSPECTIS® ProX, Pro and OAI delivery kits

* USB communication cable (item HD-035) is required to enable the feature in INSPECTIS® Basics and shall be ordered separately.

Specifications

System Requirements:

CPU	Intel Core i5. Intel Core i7 recommended.
Operating System	Windows 7/8.1/10 (x64 version Professional, Enterprise)
Memory	8 GB of RAM, 16 GB recommended.
Hard Disk	200 GB of Free Space
Display	Full HD. 4K, 3840×2160 pixels recommended.
Ports	1x USB2.0 port 1x USB3.0 port 1x PCIe Gen2 x4 (If PCIe HDMI capture is used)
Recommended Computers	Station: HP ProDesk, Intel Core i7, 16 GB, 4K graphical card. Laptop: HP ProBook, Intel Core i7, 15.6", 16 GB, Full HD monitor

Ordering numbers Software with Video Converter:

INSPECTIS® Basics with Full HD USB3.0 Video Converter	HD-031
INSPECTIS® Pro with FHD USB3.0 Video Converter including USB dongle and communication cable	HD-032
INSPECTIS® ProX with FHD USB3.0 Video Converter including USB dongle and communication cable	HD-032-PX
INSPECTIS® Basics with 4K HD USB3.0 Video Converter	HD-043
INSPECTIS® Pro with 4K HD USB3.0 Video Converter including USB dongle and communication cable	HD-044
INSPECTIS® ProX with 4K HD USB3.0 Video Converter including USB dongle and communication cable	HD-044-PX
INSPECTIS® Basics with 4K HD PCIe Video Converter	HD-045
INSPECTIS® Pro with 4K HD PCIe Video Converter including USB dongle and communication cable	HD-046
INSPECTIS® ProX with 4K HD PCIe Video Converter including USB dongle and communication cable	HD-046-PX

Ordering numbers Software:

INSPECTIS® Basics. Image Capture software with Built-in Camera Controls	HD-131
INSPECTIS® Pro including USB dongle and communication cable	HD-132
INSPECTIS® ProX including USB dongle and communication cable	HD-133
INSPECTIS® OAI including USB dongle and communication cable	HD-134
Upgrade INSPECTIS® software from Basics to Pro including USB dongle and communication cable	* -BP
Upgrade INSPECTIS® software from Basics to ProX including USB dongle and communication cable	* -BX
Upgrade INSPECTIS® software from Pro to Pro-X	* -PX
Inspectis USB communication Cable (optional for INSPECTIS® Basics)	HD-035

INSPECTIS® software is delivered with best-on-the-market plug&play USB3.0 and PCIe video converters. INSPECTIS® software is compatible with other microscope cameras!



Reseller

INSPECTIS

Quality of Inspection

Inspectis Optical Systems
Stockholm, Sweden

www.inspect-is.com
info@inspect-is.com